



CUSTOMER	
ATTENTION 1	2 Mega CMOS
ATTENTION 2	32x32mm
MODEL	HCM-6770TN
CODE NO	

Color Camera Module

SPECIFICATIONS

SEP. 03. 2015

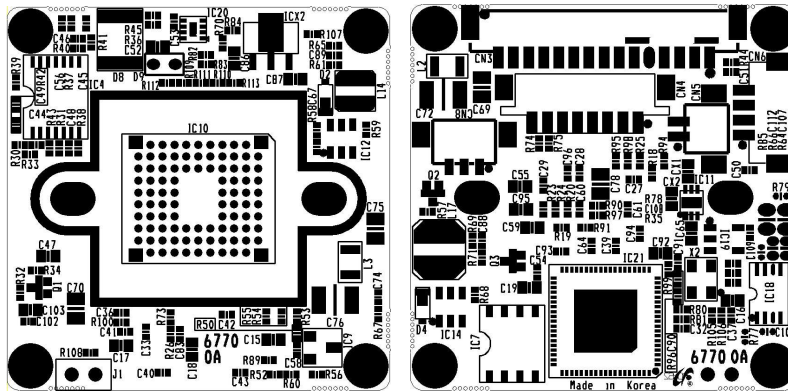

P&A Corporation



Table of Contents

- Revision History

1. Features	4
2. Applications & Information	
2-1. General Specifications & Functions	5
2-2. Block Diagram	6
2-3. I/O Interface Specifications	
2-3-1. I/O Circuit	7
2-3-2. I/O Specifications	8
2-3-3. ADC Key	10
2-3-4. PCB Layout	11
2-4. PCB Outline Dimensions	12
2-5. OSD Menu tree	13
2-6. OSD Menu Functions	15
3. UART Protocol	28
4. Packing Information	39
5. Reference Data Sheet	
5-1. OLPF(Optical Low Pass Filter) Specifications	40
5-1-1. OLPF for general lens	40
5-1-2. OLPF for general lens-2	41
5-1-3. OLPF for TDN lens	41
5-1-4. OLPF for Night Vision	42
5-2. I/O Connector Specifications	43
6. Ordering Information(Model Configuration)	44



- Revision History

Date	Version	Description
AUG.18 2015	0A	Establishment
SEP.03 2015	1A	Update menu
JAN.15 2016	2A	Update Default Setting



1. Features

■ 1/3" IMX322LQJ 2MEGA SONY CMOS

High definition 12-bit digital image signals offering 2 mega pixels are obtained with high speed of 30 fps and with low power consumption.

■ High Resolution 1100(Color)/(BW) TV Lines

This camera has realized high resolution of **1100(Color)/(BW)** TV lines using the top-notch full digital image processing, **12 Bit A/D** serial signal processing and special algorithm technologies.

■ DNR (Digital Noise Reduction, 2D+3D)

The DNR technology eliminates noise thus generating a distinct and clear image.

This camera DNR function utilizes both an enhanced 2D filter reducing noise in the brightness of the image and an enhanced 3D filter reducing caused by movement.

■ DAY&NIGHT (Output the Filter changing signal)

This camera has the Day&Night function which outputs the filter changing signal with detecting the illumination condition. Day&Night operation feature an 'auto' mode which switches between day and night mode automatically based upon the level of illumination on the scene.

EXTERN mode changes between day and night operation upon triggering from an external source(Optional). And also, the COLOR mode operates in daytime conditions to provide optimum colors, and B/W mode operates in night-time conditions to enhance the definition of the image.

■ OSD (On Screen Display)

This camera supports the OSD function which is used with multi language. And so, the camera can be controlled by selecting text displayed on the monitor screen.

■ Privacy Mask Function

Privacy masking allows for the 'blanking' of specific areas of a scene, where the viewing or recording of images is prohibited or undesired.

The technology of this camera allows for the user defined setting of a four point polygonal mask, which is overlaid onto the video signal output.

■ AHD Analog HD video

HCM-6770TN is a video D/A solution for converting HD digital video signal into the analog domain that is suitable for transmission over signal coax-cable over long reach.

The major application is the security surveillance applications require transmission of HD video.



2. Applications & Information

2-1. General Specifications & Functions

Items	Sub-items	HCM-6770TN
CMOS	Device	1/3 2MEGA CMOS
	Total	2000(H) × 1241(V)
	Effective	1984(H) x 1097 (V)
Performance	Horizontal/Verical Resolution	1080p
	Minimum illumination(F1.2)	Color : 0.1 Lux(50IRE) / 0.02 Lux(15IRE) B/W : 0.08 Lux(50IRE) / 0.002 Lux(15IRE)
	S/N Ratio	More than 50dB (AGC off)
	Frame	30fps Full HD
Functions	OSD	English/Chinese(S)/Chinese/German/Francais/Italian/Spanish/Polish/Russian/Portuguese/Dutch/Turkish
	Day&Night	Auto/Color/B&W/EXTERN
	ATW	1800 ~ 10500K
	High Speed Shutter	1/30(1/25) ~ 1/50Ksec
	WDR	N/A
	D-WDR	Off/ON/Auto
	BLC	Size, Position, Level
	HSBLC	Size, Position, Level, Mode
	AGC	Level Setting(0~15)
	D-Zoom	NA
	Camera ID	Off/On (Letters A to Z, Numerals 0 to 9,
	White Balance	ATW/AwcSet/Indoor/Outdoor/Manual/AWB
	DNR	2D+3DNR, OFF/LOW/MIDDLE/HIGH
	Motion Detection	Off/ON
	Privacy Mask	4 Areas (On/Off, Color, Position)
	Sens-Up	x2,x4,x6,x8,x10,x15,x20,x25,x30
De-Fog	Off/AutoI	
Etc. Function	Sharpness, Reverse(H,V)	0~10, Freeze,Mirror,Nega.Image
	Color Bar	N/A
	In/Output	Alarm Output, Ext IR Mode, IR LED Output
	Upstream data	VBI data extraction for data communication
Video Output	Monitor Video Output	N/A
	HD Video Output	AHD HD video output 1.0Vp-p (75ohm Terminated)
Power Consumption	DC 12V±10%, Less than 1.8Watts	
Operating Temperature	Absolute : -10°C ~ +50°C	
Operating Humidity	Less than 90%	
Dimension	32mm x 32 mm x 1.0t	



2-2. Block Diagram

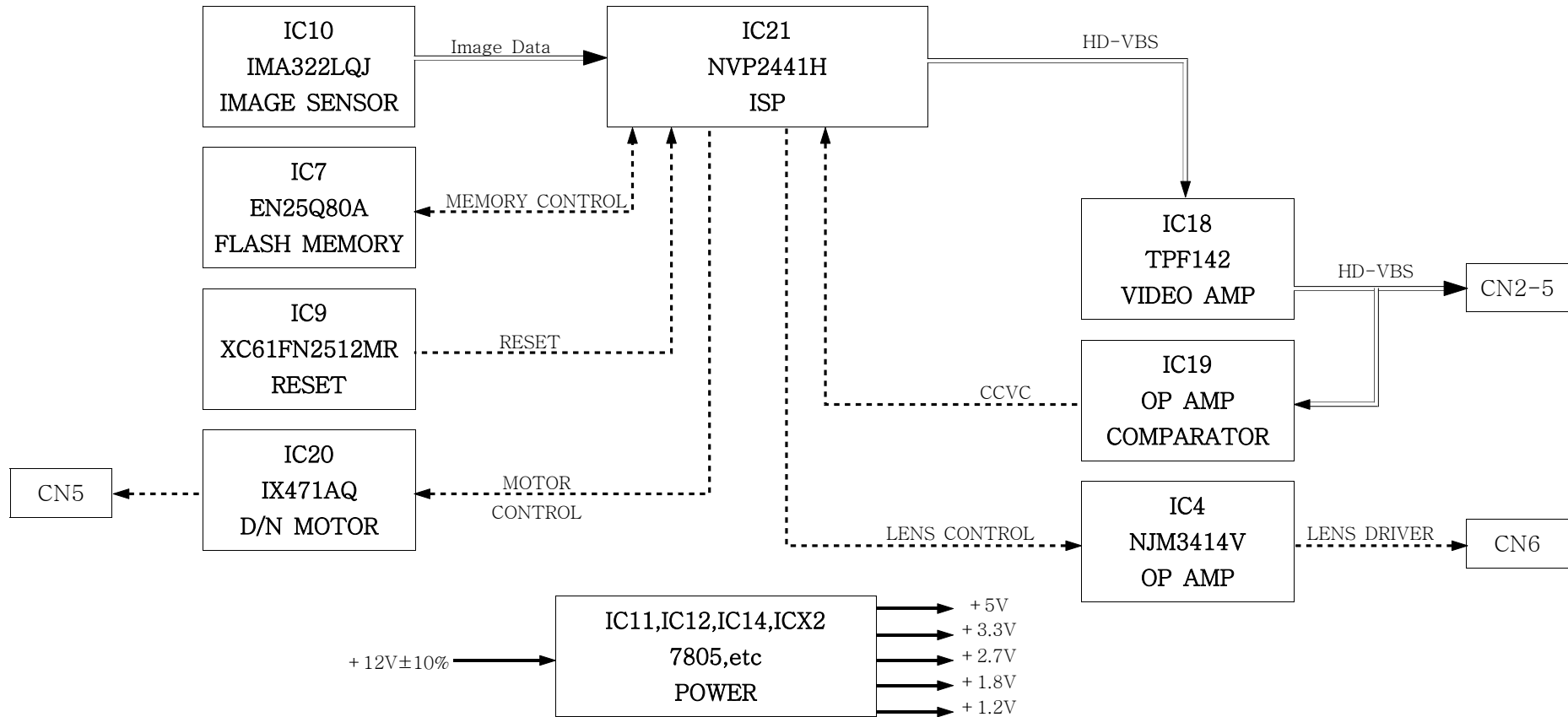



2-3. I/O Interface Specifications 2-3-1. I/O Circuit

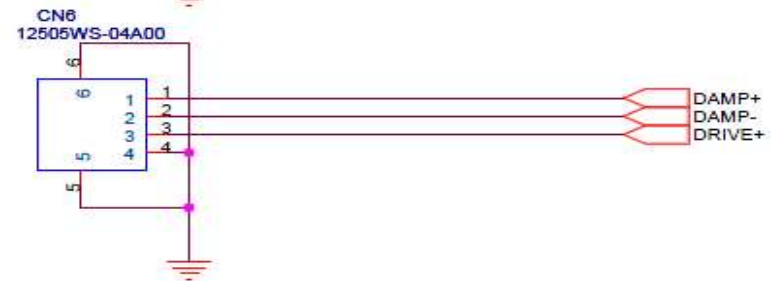
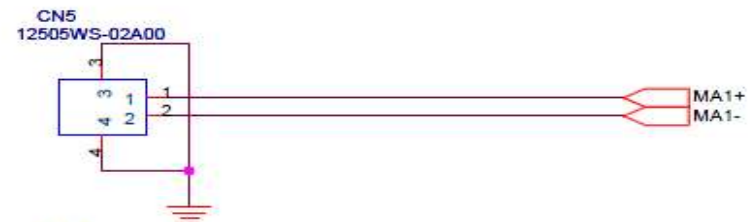
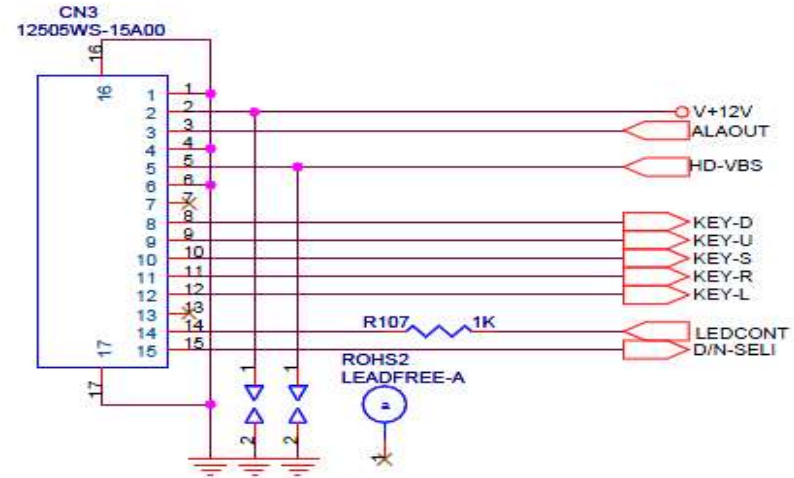
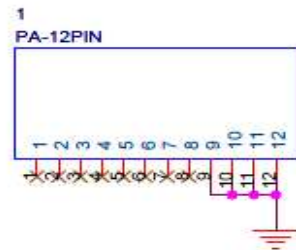
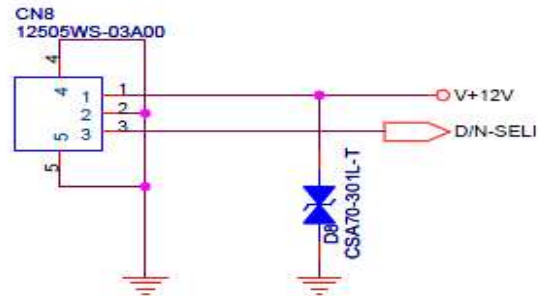
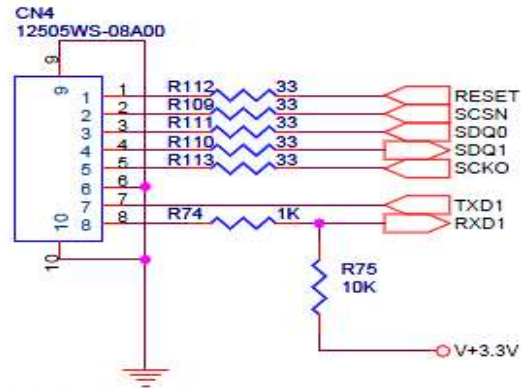



2-3-2. I/O Specifications

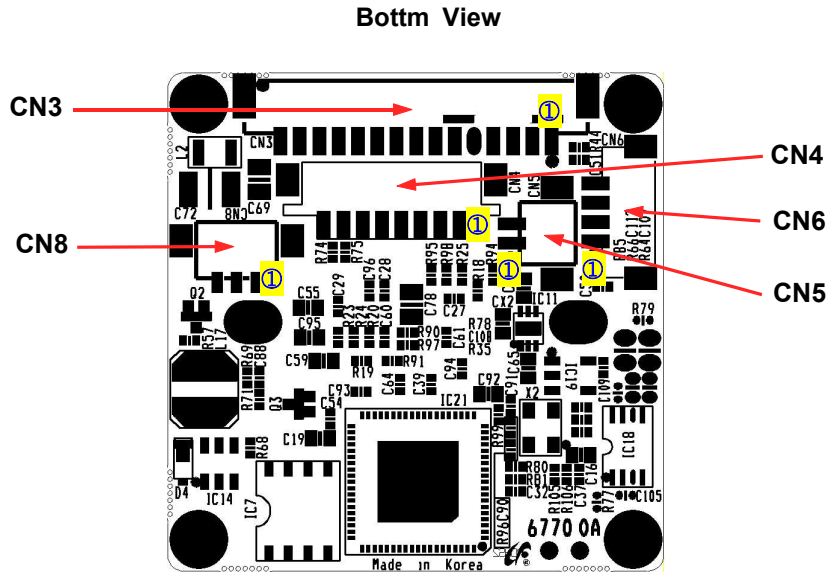

① CN3 : I/O Connector -1

Pin NO	Pin Name	Description	Normal	Active	I/O
1	GND	Board Ground	-	-	-
2	V+12V	DC+12V Input	DC+12V	DC+12V	I
3	ALAOUT	Alarm Output	Open	0V	O
4	GND	Board Ground	-	-	-
5	HD-VBS	TVI HD Composite Video Output	1Vp-p	1Vp-p	O
6	GND	Board Ground	-	-	-
7	NC	-	-	-	-
8	KEY-D	OSD Control DOWN	3.3V	0V	I
9	KEY-U	OSD Control Up	3.3V	0V	I
10	KEY-S	ADC KEY INPUT/OSD Control Enter	3.3V	ADC/0V	I
11	KEY-R	OSD Control RIGHT	3.3V	0V	I
12	KEY-L	OSD Control LEFT	3.3V	0V	I
13	NC	-	-	-	-
14	LED CONT	Day & Night Control Output	0V	3.3V	O
15	D/N-SELI	External Day & Night Select Input	Open(3.3V)	0V	I
Yeonho Electronics, 12505WS-15A00					



② CN4 : Connector for upgrading Camera Program

Pin NO	Pin Name	Description	Normal	Active	I/O
1	JMODE	JTAG MODE(0:Program Debug, 1:Nomal)	Open	3.3V/0V	I
2	JTCK	JTAG CLOCK	Open	3.3V/0V	I
3	JTDO	JTAG DATA OUT	Open	3.3V/0V	I
4	JTDI	JTAG DATA IN	Open	3.3V/0V	I
5	JTMS	JTAG ENABLE	Open	3.3V/0V	I
6	GND	Board Ground	-	-	-
7	TXD1	UART Transmit OUTPUT1(RS232)	3.3V/0V	3.3V/0V	O
8	RXD1	UART Receive INPUT1(RS232)	0V	3.3V/0V	I
Yeonho Electronics, 12505WS-08A00					

③ CN5 : Day & Night Motor Control Connector

Pin NO	Pin Name	Description	Normal	Active	I/O
1	MA+	Day & Night Motor Drive - Output	Open	0V/5V	O
2	MA-	Day & Night Motor Drive + Output	Open	5V/0V	O
Yeonho Electronics, 12505WS-02A00					

④ CN6 : Auto Iris Lens Control Connector

Pin NO	Pin Name	Description	Active	I/O
1	DAMP+	DC Iris Damping Motor +	DAMP+	O
2	DAMP-	DC Iris Damping Motor -	DAMP-	O
3	DRIVE+	DC Iris Motor Drive	DRIVE+	O
4	GND	Board GROUND	-	-
Yeonho Electronics, 12505WS-04A00				

⑤ CN8 : Extra DC+12V & Analog VBS Output

Pin NO	Pin Name	Description	Normal	Active	I/O
1	V+12V	Extra DC+12V Output(Use IR LED Board)	DC+12V	DC+12V	O
2	GND	Board GROUND	-	-	-
3	D/N-SELI	External Day & Night Select Input	Open(3.3V)	0V	I
Yeonho Electronics, 12505WS-03A00					



2-3-3. ADC KEY

① KEY-VOLTAGE

net Name	Direction	Key Name	Voltage
KEY-S	⊙	SELECT(ENTER)	0.00V
KEY-U	▲	UP	0.66V
KEY-D	▼	DOWN	1.21V
KEY-L	◀	LEFT	1.92V
KEY-R	▶	RIGHT	2.65V

② Internal/External Circuit

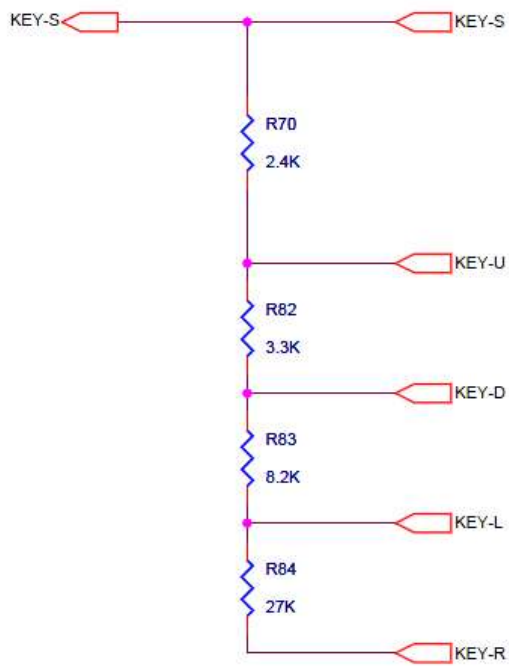

③ External Switch(Sample)

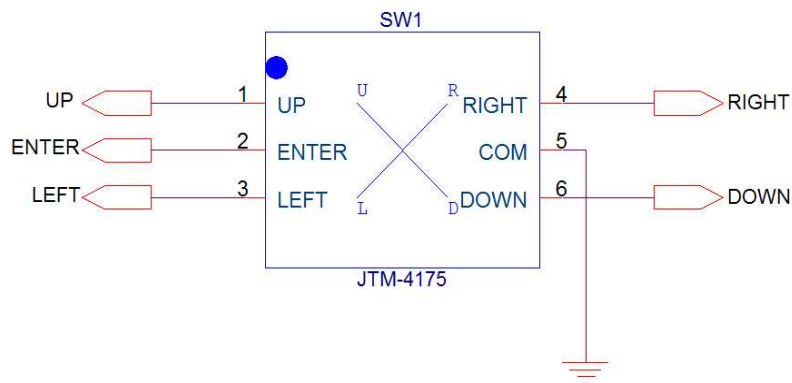



2-4. PCB Outline Dimensions

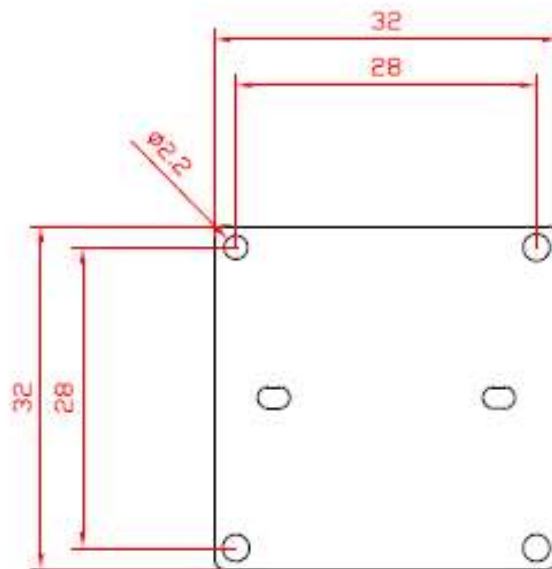
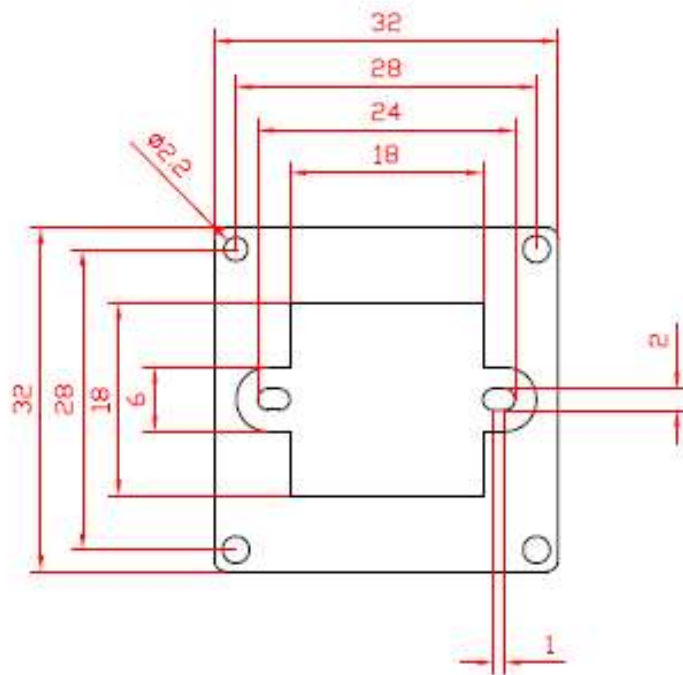

BOTTOM VIEW



2-5. OSD Menu tree

Main Menu	Sub Menu	Descriptions
LENS	-	DC,MANUAL
	MODE	INDDOR,OUTDOOR
	IRIS SPEED	0~15
EXPOSURE	SHUTTER	AUTO,1/30(25)~1/50000,x2~x30
	AGC	0~15
	SENS-UP	OFF,AUTO(X2~X30)
	BRIGHTNESS	0~100
	D-WDR	OFF,ON,AUTO
	DEFOG	OFF,AUTO
BACKLIGHT	-	OFF,BLC,HSBLC
	LEVEL	LOW,MIDDLE,HIGH
	AREA	POSITION,SIZE
	DEFAULT	ⓔ
	SELECT	AREA1~AREA4
	DISPLAY	OFF,ON
	BLACK MASK	OFF,ON
	LEVEL	0~100
	MODE	NIGHT,ALLDAY
	DEFAULT	ⓔ
WHITE BAL	-	ATW,AWCSET,INDOOR,DOOUTDOOR,MANUAL,AWB
	BLUE	0~100
	RED	0~100
DAY&NIGHT	-	AUTO,COLOR,B/W,EXT
	D->N (AGC)	1~255
	D->N (DELAY)	0~60
	N->D(AGC)	1~255
	N->D(DELAY)	0~60
	BURST	OFF,ON
	IR SMART	OFF,ON



Main Menu	Sub Menu	Descriptions
NR	2DNR	OFF,LOW,MIDDLE,HIGH
	3DNR	OFF,LOW,MIDDLE,HIGH
SPECIAL	CAM TITLE	OFF,ON
	D-EFFECT	FREEZE,MIRROR,NEG.IMAGE
	MOTION	OFF,ON
	PRIVACY	OFF,ON
	LANGUAGE	English/Chinese(S)/Chinese/German/Francais/Italian/Spa nish/Polish/Russian/Portuguese/Dutch/Turkish
	DEFECT	OFF,ON
	RS485	OFF,ON (Not ablable)
ADJUST	SHARPNESS	OFF,AUTO
	MONITOR	LCD,CRT
	LSC	OFF,ON
	VIDEO.OUT	NTSC,PAL
EXIT	-	SAVE&END, RESET, NOT SAVE



2-6 OSD Menu Functions

◆ Main Menu



■ LENS

Select the Lens operation type.

■ EXPOSURE

Adjust camera exposure.

■ BACKLIGHT

The function is used to set the Back Light Compensation(BLC) and High Suppress High Light Compensation(HSBLC).

■ WHITE BAL

This function is used to set the White Balance operation which adjusts the color scheme.

■ DAY/NIGHT

The function is used to set the Day/Night function which switches day/Night mode automatically based on the level of illumination.

■ NR

The function is used to reduce the noise using the Digital Noise Reduction (DNR).

■ SPECIAL

The function is used to configure the Motion Detection operation and Alarm function which sense the movement of the scene and cam title, digital effect, privacy, language, defect

■ ADJUST

The function is used to adjust the camera picture(Sharpness, Gamma, Monitor type, lens shading compensation, video format).

■ EXIT

SAVE&END: The function is used to save the various settings of the internal OSD menu.

RESET: The function initializes all the internal OSD menu settings.

NOT SAVE: The function is used to cancel the current OSD menu settings.

KEY FUNCTIONS

▲: Up

▼: Down

◀: Left

▶: Right

Ⓢ: Enter(Setup)



◆ LENS

▶ LENS "◀" "▶" "Ⓜ"



FUNCTION	OPTION	DESCRIPTION
LENS	DC MANUAL	DC (Automatic IRIS Control) MANUAL (Electronic Shutter Control)

■ DC "▲" "▼" "◀" "▶" "Ⓜ"

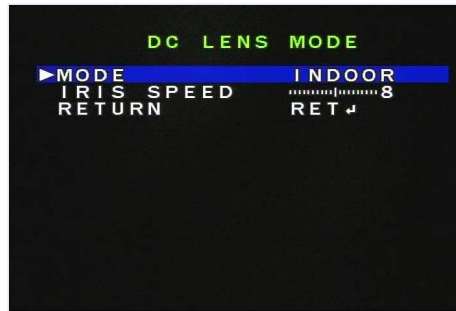

FUNCTION	OPTION	DESCRIPTION
MODE	INDOOR,OUTDOOR	Selects the auto exposure condition
IRIS SPEED	0~15	Sets the Iris control speed

◆ EXPOSURE

▶ EXPOSURE "Ⓜ"

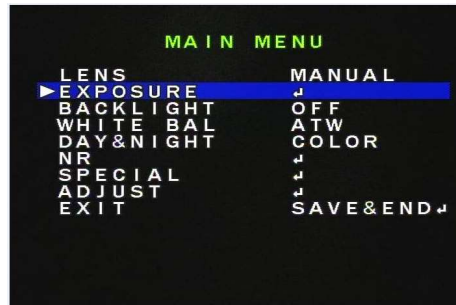

Automatic exposure automatically controls exposure by recognizing the brightness of the object.



■ EXPOSURE "▲" "▼" "◀" "▶" "Ⓜ"

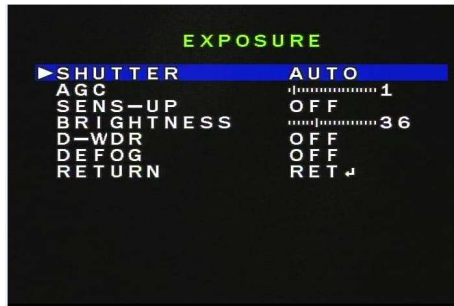

FUNCTION	OPTION	DESCRIPTION
SHUTTER	AUTO, 1/30(25)~1/50000, x2~x30	Executes the Shutter speed automatically Executes the user setting high-shutter speed Executes the user setting sens-up speed
AGC	0~15	Adjusts the agc level
SENS-UP	OFF,AUTO	Sets the sens-up speed
BRIGHTNESS	0~100	Sets the screen brightness
D-WDR	OFF,ON,AUTO	Sets the digital wide dynamic range
DEFOG	OFF,AUTO	Sets the defog

■ SENS-UP "▲" "▼" "◀" "▶" "Ⓜ"

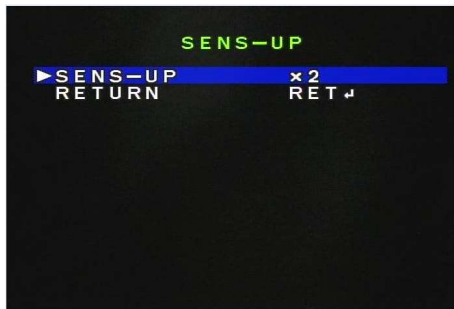

FUNCTION	OPTION	DESCRIPTION
SENS-UP	x2,x4,x6,x8,x10,x15, x20,x25,x30	Adjusts the sens-up speed

■ D-WDR "▲" "▼" "◀" "▶" "Ⓜ"



FUNCTION	OPTION	DESCRIPTION
LEVEL	0~8	Adjusts the D-WDR weight



■ DEFOG "▲" "▼" "◀" "▶" "Ⓜ"



FUNCTION	OPTION	DESCRIPTION
POS/SIZE	Ⓜ	Sets the defog control area
GRADATION	0~2	Sets the defog weight
DEFAULT	Ⓜ	Initialize the defog condition

■ POSITION(DEFOG) "▲" "▼" "◀" "▶" "Ⓜ"

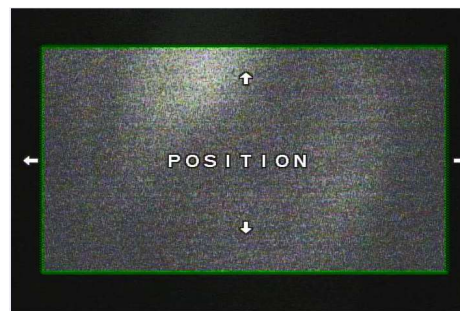

FUNCTION	OPTION	DESCRIPTION
POSITION	"▲" "▼" "◀" "▶" "Ⓜ"	Sets position of the defog area

■ SIZE(DEFOG) "▲" "▼" "◀" "▶" "Ⓜ"

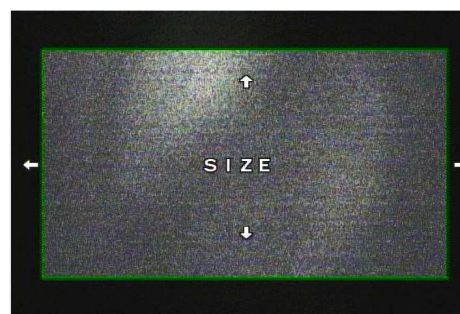

FUNCTION	OPTION	DESCRIPTION
SIZE	"▲" "▼" "◀" "▶" "Ⓜ"	Sets size of the defog area



■ RET/AGAIN(DEFOG) "▲" "▼" "◀" "▶" "Ⓜ"

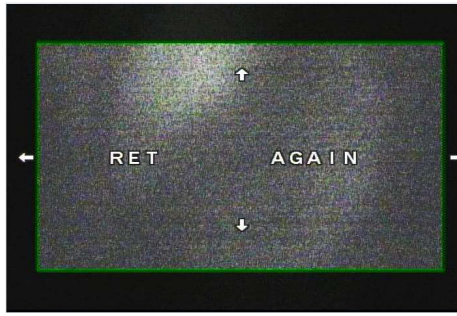

FUNCTION	OPTION	DESCRIPTION
RET	"▲" "▼" "◀" "▶" "Ⓜ"	Completes position set and size set of the defog area
AGAIN	"▲" "▼" "◀" "▶" "Ⓜ"	Retry position set and size set of the defog area

◆ BACKLIGHT

▶ BACKLIGHT "◀" "▶" "Ⓜ"



FUNCTION	OPTION	DESCRIPTION
BACKLIGHT	OFF BLC HSBLC	Off the HLC and HSBLC Use the BLC(Back Light Copensation) Use the HSBLC(High Suppress Back Light Copensation)

■ BLC "▲" "▼" "◀" "▶" "Ⓜ"



FUNCTION	OPTION	DESCRIPTION
LEVEL	LOW,MIDDLE,HIGH	Sets the blc weight
AREA	Ⓜ	Sets the blc control area
DEFAULT	Ⓜ	Initialize the blc condition



■ POSITION(BLC) "▲" "▼" "◀" "▶" "Ⓜ"

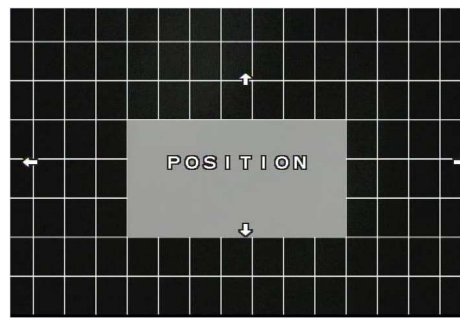

FUNCTION	OPTION	DESCRIPTION
POSITION	"▲" "▼" "◀" "▶" " " " "Ⓜ"	Sets position of the blc control area

■ SIZE(BLC) "▲" "▼" "◀" "▶" "Ⓜ"

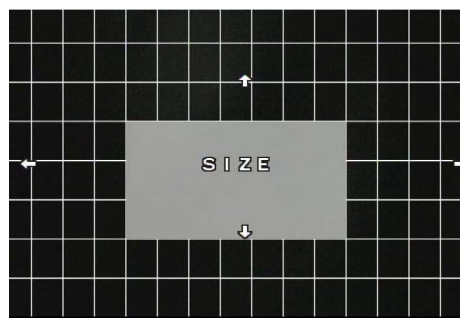

FUNCTION	OPTION	DESCRIPTION
SIZE	"▲" "▼" "◀" "▶" " " " "Ⓜ"	Sets size of the blc control area

■ RET/AGAIN(BLC) "▲" "▼" "◀" "▶" "Ⓜ"

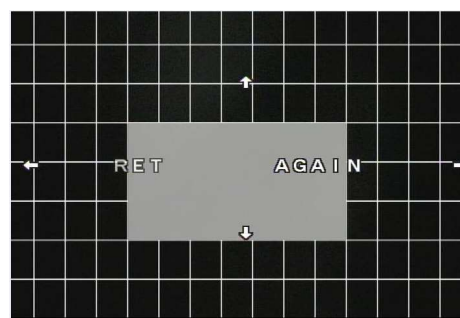

FUNCTION	OPTION	DESCRIPTION
RET	"▲" "▼" "◀" "▶" " " " "Ⓜ"	Completes position set and size set of the blc control area
AGAIN	"▲" "▼" "◀" "▶" " " " "Ⓜ"	Retry position set and size set of the blc control area



■ HSBLC "▲" "▼" "◀" "▶" "ⓐ"



FUNCTION	OPTION	DESCRIPTION
SELECT	AREA1~AREA4	Selects the hsbhc area number
DISPLAY	OFF,ON	Sets the hsbhc control area of the selected number
BLACK MASK	OFF,ON	Sets the mask On or Off
LEVEL	0~100	Sets the hsbhc weight
MODE	NIGHT,ALLDAY	Selects the hsbhc execution condition
DEFAULT	ⓐ	Initialize the hsbhc condition

■ POSITION(HSBLC) "▲" "▼" "◀" "▶" "ⓐ"

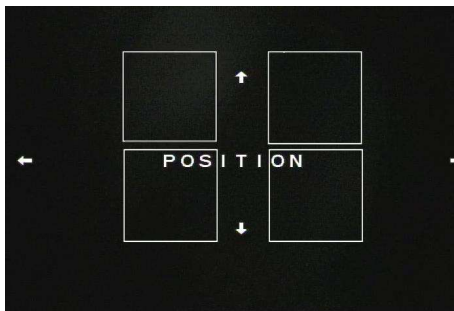

FUNCTION	OPTION	DESCRIPTION
POSITION	"▲" "▼" "◀" "▶" "ⓐ"	Sets position of the hsbhc control area

■ SIZE(HSBLC) "▲" "▼" "◀" "▶" "ⓐ"

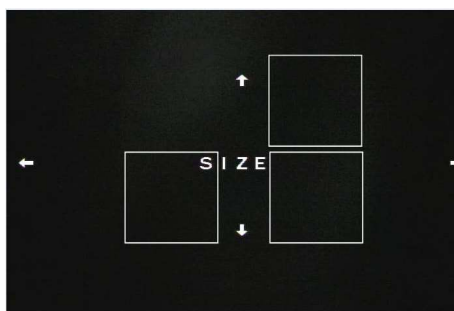



FUNCTION	OPTION	DESCRIPTION
SIZE	"▲" "▼" "◀" "▶" "Ⓜ"	Sets size of the hsbcl control area

■ **RET/AGAIN(HSBLC)** "▲" "▼" "◀" "▶" "Ⓜ"

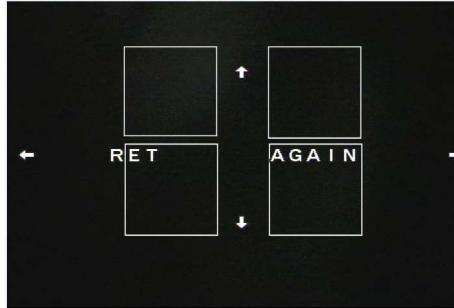

FUNCTION	OPTION	DESCRIPTION
RET	"▲" "▼" "◀" "▶" "Ⓜ"	Completes position set and size set of the hsbcl control area
AGAIN	"▲" "▼" "◀" "▶" "Ⓜ"	Retry position set and size set of the hsbcl control area

■ **NIGHT MODE(HSBLC)** "▲" "▼" "◀" "▶" "Ⓜ"

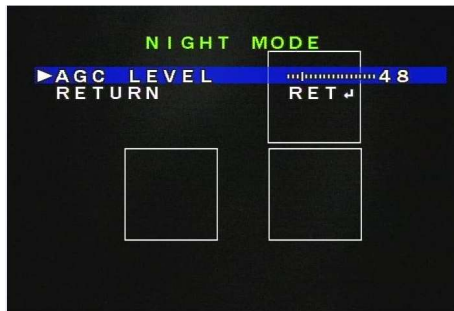

FUNCTION	OPTION	DESCRIPTION
AGC LEVEL	0~255	Sets the agc level of the selected area number

◆ **WHITE BAL**

▶ **WHITE BAL** "◀" "▶" "Ⓜ"





FUNCTION	OPTION	DESCRIPTION
WHITE BAL	ATW	Auto trace white balance
	AWCSET	This mode is used to fix the color temperature value
	INDOOR	A color temperature is fixed for use in the indoor environment
	OUTDOOR	A color temperature is fixed for use in the outdoor environment
	MANUAL	Manual white balance
	AWB	auto white balance encompassing all the color temperature space

■ MANUAL "▲" "▼" "◀" "▶" "Ⓜ"



FUNCTION	OPTION	DESCRIPTION
BLUE	0~100	Adjusts B-GAIN
RED	0~100	Adjusts R-GAIN

◆ DAY&NIGHT

▶ DAY/NIGHT "◀" "▶" "Ⓜ"

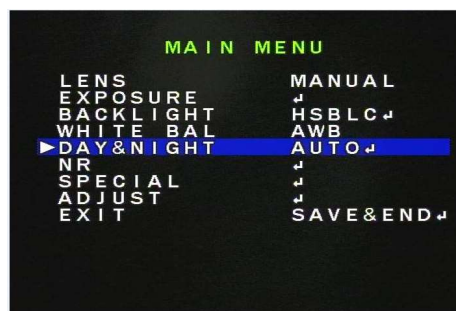

FUNCTION	OPTION	DESCRIPTION
DAY&NIGHT	AUTO	switches between day and night mode automatically based upon the level of illumination on the scene
	COLOR	fixed color
	B/W	fixed b/w
	EXT	changes between day and night operation upon triggering from an external source



■ AUTO "▲" "▼" "◀" "▶" "Ⓢ"



FUNCTION	OPTION	DESCRIPTION
D->N(AGE)	1~255	Sets the day to night thresholded level
D->N(DELAY)	0~60	Sets the day to night delay time
N->D(AGC)	1~255	Sets the night to day thresholded level
N->D(DELAY)	0~60	Sets the night to day delay time

■ B/W "▲" "▼" "◀" "▶" "Ⓢ"

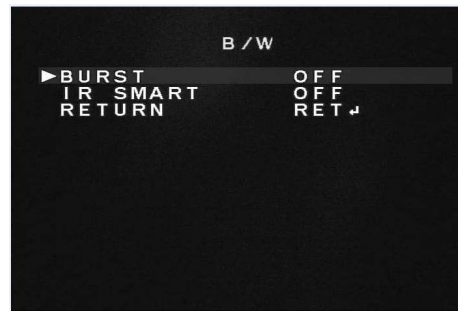

FUNCTION	OPTION	DESCRIPTION
BURST	OFF,ON	Sets the color burst in Night status to On or Off
IR SMART	OFF,ON	Brightness of IR and saturation phenomenon are automatically adjusted

■ IR SMART "▲" "▼" "◀" "▶" "Ⓢ"

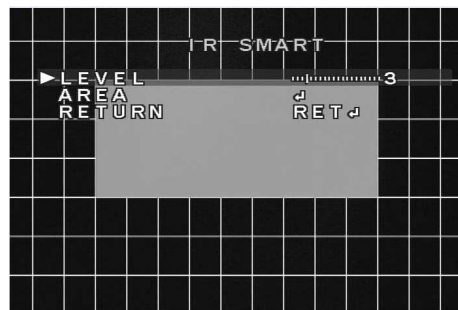

FUNCTION	OPTION	DESCRIPTION
LEVEL	0~15	Sets the IR SMART weight
AREA	Ⓢ	Sets the position and the size of the IR SMART control



■ POSITION(IR SMART) "▲" "▼" "◀" "▶" "Ⓢ"

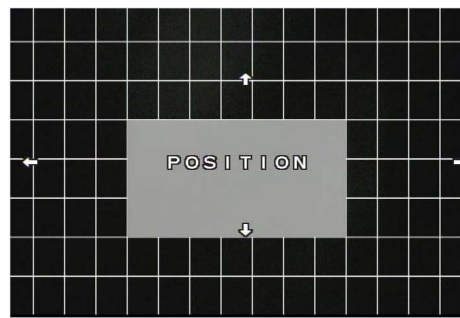

FUNCTION	OPTION	DESCRIPTION
POSITION	"▲" "▼" "◀" "▶" "Ⓢ"	Sets position of the IR SMART control area

■ SIZE(IR SMART) "▲" "▼" "◀" "▶" "Ⓢ"

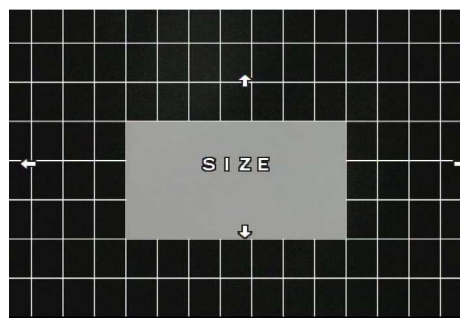

FUNCTION	OPTION	DESCRIPTION
SIZE	"▲" "▼" "◀" "▶" "Ⓢ"	Sets size of the IR SMART control area

■ RET/AGAIN(IR SMART) "▲" "▼" "◀" "▶" "Ⓢ"

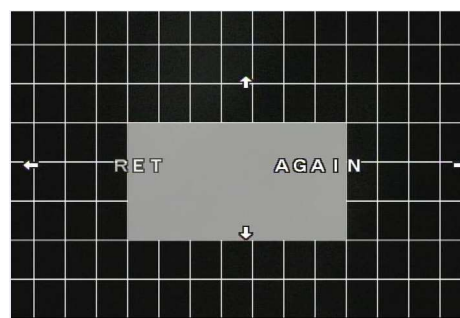

FUNCTION	OPTION	DESCRIPTION
RET	"▲" "▼" "◀" "▶" "Ⓢ"	Completes position set and size set of the IR SMART control area
AGAIN	"▲" "▼" "◀" "▶" "Ⓢ"	Retry position set and size set of the IR SMART control area



■ EXT "▲" "▼" "◀" "▶" "Ⓜ"

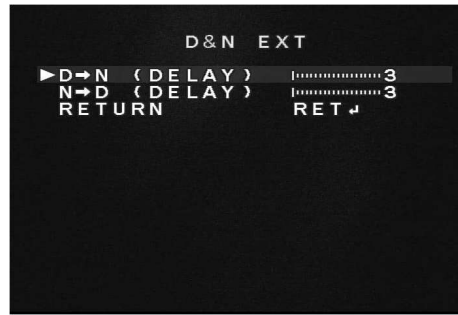

FUNCTION	OPTION	DESCRIPTION
D->N(DELAY)	0~60	Sets the day to night delay time
N->D(DELAY)	0~60	Sets the night to day delay time

◆ NR

▶ NR "Ⓜ"



Noise Reduction (NR) is a function to acquire output images of high quality and to enhance compression efficiency.

It provides Edge Preserving 2D NR and Motion Adaptive 3D NR

■ NR "▲" "▼" "◀" "▶" "Ⓜ"

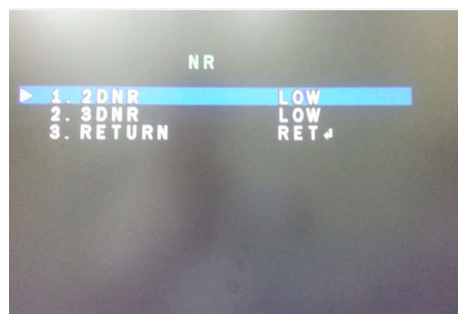

FUNCTION	OPTION	DESCRIPTION
2DNR	OFF,LOW,MIDDLE, HIGH	Sets the 2DNR weight
3DNR	OFF,LOW,MIDDLE, HIGH	Sets the 3DNR weight



◆ SPECIAL

▶ SPECIAL "Ⓜ"

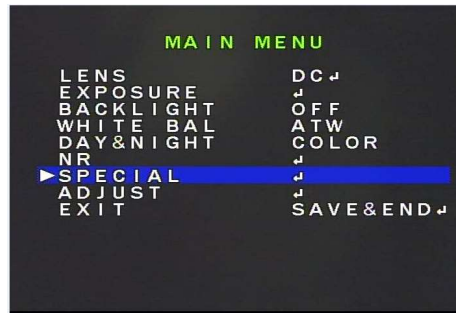

The function is used to configure the Motion Detection operation and Alarm function which sense the movement of the scene and cam title, digital effect, privacy, language, defect

■ SPECIAL "▲" "▼" "◀" "▶" "Ⓜ"



FUNCTION	OPTION	DESCRIPTION
CAM TITLE	OFF,ON	Sets the camera title
D-EFFECT	Ⓜ	Sets the digital effect item
MOTION	OFF,ON	Sets the motion On or Off
PRIVACY	OFF,ON	Sets the privacy mask On or Off
LANGUAGE	English/Chinese(S)/Chinese/German/French/Italian/Spanish/Polish/Russian/Portuguese/Dutch/Turkish	Select the languages
DEFECT	Ⓜ	Sets the defect compensation
RS485	Ⓜ	Sets the RS485 (Not available)



■ CAM TITLE "▲" "▼" "◀" "▶" "ⓔ"

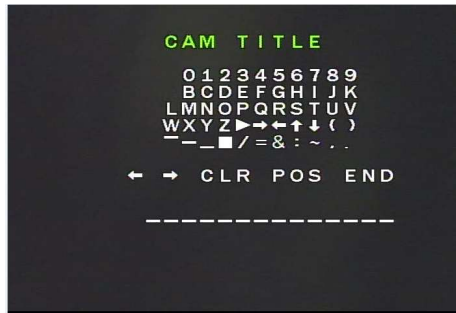

Up to 14 letters can be displayed on the screen.

■ D-EFFECT "▲" "▼" "◀" "▶" "ⓔ"



FUNCTION	OPTION	DESCRIPTION
FREEZE	OFF,ON	A still image can be output
MIRROR	OFF,MIRROR, V-FLIP,ROTATE	The image can be turned upside down, flipped or rotated 180° before print-out
NEG.IMAGE	OFF,ON	A negative image of the original can be output

■ MOTION "▲" "▼" "◀" "▶" "ⓔ"

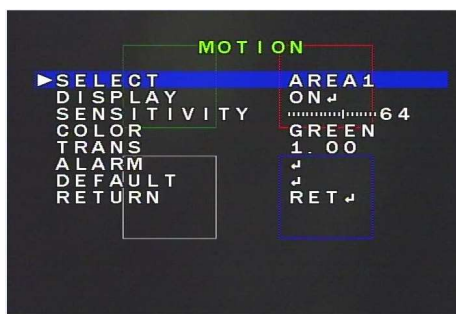

FUNCTION	OPTION	DESCRIPTION
SELECT	AREA1~AREA4	Selects the motion control area number
DISPLAY	OFF,ON	Sets the motion control area of the selected number
SENSITIVITY	0~100	Sets the motion detection sensitivity
COLOR	GREEN,BLUE,WHITE, RED	Sets the motion display color
TRANS	0.00, 0.25, 0.75,	Sets the motion display transparence



ALARM	Ⓜ	Sets the motion alarm display type and alarm port
DEFAULT	Ⓜ	Initialize the motion condition

■ POSITION(MOTION) "▲" "▼" "◀" "▶" "Ⓜ"

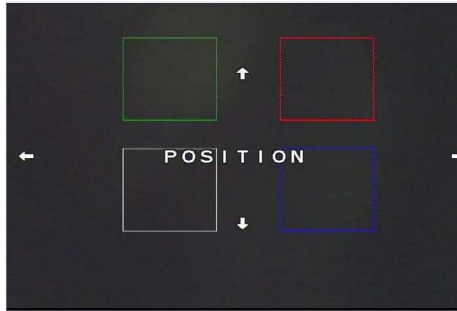

FUNCTION	OPTION	DESCRIPTION
POSITION	"▲" "▼" "◀" "▶" "Ⓜ"	Sets position of the motion control area

■ SIZE(MOTION) "▲" "▼" "◀" "▶" "Ⓜ"

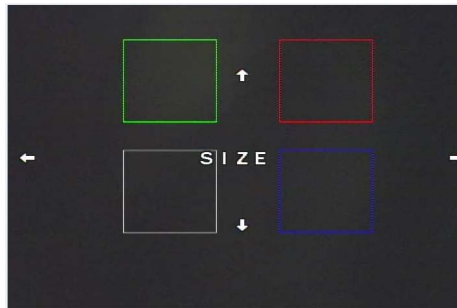

FUNCTION	OPTION	DESCRIPTION
SIZE	"▲" "▼" "◀" "▶" "Ⓜ"	Sets size of the motion control area

■ RET/AGAIN(MOTION) "▲" "▼" "◀" "▶" "Ⓜ"

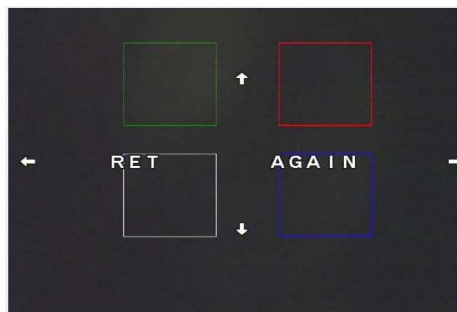



FUNCTION	OPTION	DESCRIPTION
RET	"▲" "▼" "◀" "▶" " Ⓧ"	Completes position set and size set of the motion control area
AGAIN	"▲" "▼" "◀" "▶" " Ⓧ"	Retry position set and size set of the motion control area

■ **ALARM** "▲" "▼" "◀" "▶" "Ⓧ"

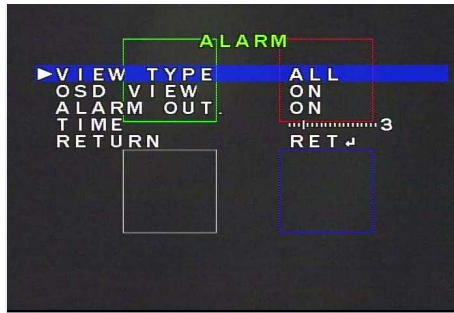

FUNCTION	OPTION	DESCRIPTION
VIEW TYPE	OFF,ALL,BLOCK, OUTLINE	Sets the motion display type
OSD VIEW	OFF,ON	Sets the text alarm On or Off
ALARM OUT	OFF,ON	Sets the alarm port On or Off
TIME	0~3	Sets the text alarm display time

■ **PRIVACY** "▲" "▼" "◀" "▶" "Ⓧ"

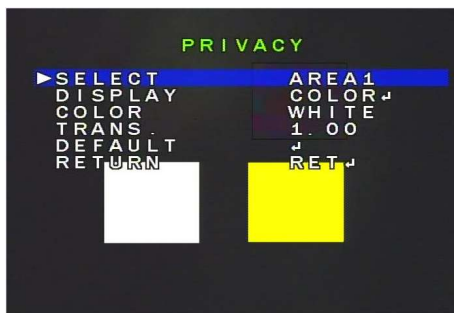

FUNCTION	OPTION	DESCRIPTION
SELECT	AREA1~AREA4	Selects the privacy control area number
DISPLAY	OFF,MOSAIC,INV., COLOR	Sets the privacy control area of the selected number
COLOR	RED,BLUE,YELLOW,GREEN,CYAN,USER,WHITE,BLACK	Sets the privacy color
TRANS	0.00, 0.25, 0.50, 0.75, 1.00	Sets the privacy display transparency
DEFAULT	Ⓧ	Initialize the privacy condition



■ POSITION(PRIVACY) "▲" "▼" "◀" "▶" "Ⓜ"

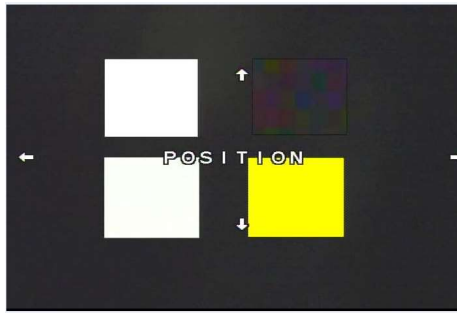

FUNCTION	OPTION	DESCRIPTION
POSITION	"▲" "▼" "◀" "▶" "Ⓜ"	Sets position of the privacy control area

■ SIZE(PRIVACY) "▲" "▼" "◀" "▶" "Ⓜ"

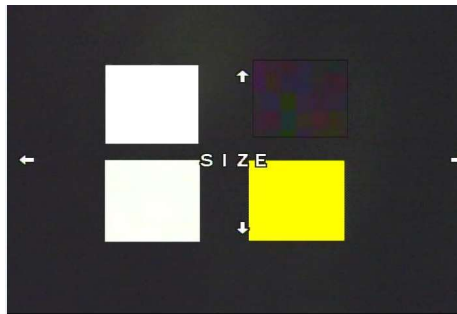

FUNCTION	OPTION	DESCRIPTION
SIZE	"▲" "▼" "◀" "▶" "Ⓜ"	Sets size of the privacy control area

■ RET/AGAIN(PRIVACY) "▲" "▼" "◀" "▶" "Ⓜ"

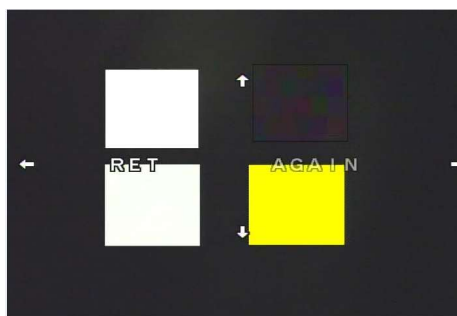

FUNCTION	OPTION	DESCRIPTION
RET	"▲" "▼" "◀" "▶" "Ⓜ"	Completes position set and size set of the privacy control area
AGAIN	"▲" "▼" "◀" "▶" "Ⓜ"	Retry position set and size set of the privacy control area



■ DPC "▲" "▼" "◀" "▶" "Ⓢ"



FUNCTION	OPTION	DESCRIPTION
LIVE DPC	OFF,ON	Selects the real time defect compensation On or Off
WHITE DPC	OFF,ON	Sets the white defect compensation On or Off
BLACK DPC	OFF,ON	Sets the black defect compensation On or Off

■ LIVE DPC "▲" "▼" "◀" "▶" "Ⓢ"



FUNCTION	OPTION	DESCRIPTION
AGC LEVEL	0~255	Adjusts the illuminance for live defect compensation
LEVEL	0~255	Sets the defect compensation weight

■ WHITE DPC "▲" "▼" "◀" "▶" "Ⓢ"

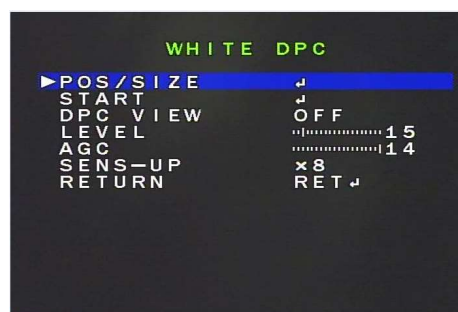

FUNCTION	OPTION	DESCRIPTION
POS/SIZE	Ⓢ	Sets the white defect area
START	Ⓢ	Starts the white defect adjust
DPC VIEW	OFF,ON	displays the current defect position



LEVEL	0~100	Sets the white defect compensation weight
AGC	0~14	Sets the agc level for the white defect adjust
SENS-UP	x2~x30	Sets the sens-up value for the white defect adjust

■ POSITION(WHITE DPC) "▲" "▼" "◀" "▶" "Ⓜ"



FUNCTION	OPTION	DESCRIPTION
POSITION	"▲" "▼" "◀" "▶" "Ⓜ"	Sets position of the white defect control area

■ SIZE(WHITE DPC) "▲" "▼" "◀" "▶" "Ⓜ"



FUNCTION	OPTION	DESCRIPTION
SIZE	"▲" "▼" "◀" "▶" "Ⓜ"	Sets size of the white defect control area

■ RET/AGAIN(WHITE DPC) "▲" "▼" "◀" "▶" "Ⓜ"





FUNCTION	OPTION	DESCRIPTION
RET	"▲" "▼" "◀" "▶" " Ⓜ"	Completes position set and size set of the white defect control area
AGAIN	"▲" "▼" "◀" "▶" " Ⓜ"	Retry position set and size set of the white defect control area

■ **BLACK DPC** "▲" "▼" "◀" "▶" "Ⓜ"



FUNCTION	OPTION	DESCRIPTION
POS/SIZE	Ⓜ	Sets the black defect area
START	Ⓜ	Start the black defect adjust
DPC VIEW	OFF,ON	displays the current defect position
LEVEL	0~100	Sets the black defect compensation weight

■ **POSITION(BLACK DPC)** "▲" "▼" "◀" "▶" "Ⓜ"



FUNCTION	OPTION	DESCRIPTION
POSITION	"▲" "▼" "◀" "▶" " Ⓜ"	Sets position of the black defect control area

■ **SIZE(BLACK DPC)** "▲" "▼" "◀" "▶" "Ⓜ"





FUNCTION	OPTION	DESCRIPTION
SIZE	"▲" "▼" "◀" "▶" "Ⓜ"	Sets size of the black defect control area

■ RET/AGAIN(BLACK DPC) "▲" "▼" "◀" "▶" "Ⓜ"



FUNCTION	OPTION	DESCRIPTION
RET	"▲" "▼" "◀" "▶" "Ⓜ"	Completes position set and size set of the black defect control area
AGAIN	"▲" "▼" "◀" "▶" "Ⓜ"	Retry position set and size set of the black defect control area

◆ ADJUST

▶ ADJUST "Ⓜ"



The function is used to adjust the camera picture(Sharpness, Gamma, Monitor type,lens shading compensation, video format).

■ ADJUST "▲" "▼" "◀" "▶" "Ⓜ"

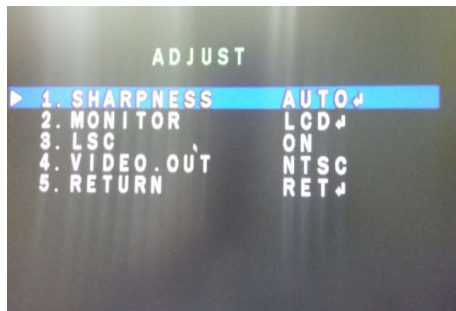



FUNCTION	OPTION	DESCRIPTION
SHAPNESS	OFF,AUTO	Adjusts the sharpness
MONITOR	LCD,CRT	Selects the monitor type
LSC	OFF,ON	Sets the lens shading compensation On or Off
VIDEO.OUT	NTSC,PAL	Selects the video output format

■ SHARPNESS "▲" "▼" "◀" "▶" "Ⓢ"



FUNCTION	OPTION	DESCRIPTION
LEVEL	0~10	Sets the sharpness weight
START AGC	0~255	Adjsts the sharpness curve accoding to agc
END AGC	0~255	Adjsts the sharpness curve accoding to agc

■ MONITOR(LCD) "▲" "▼" "◀" "▶" "Ⓢ"

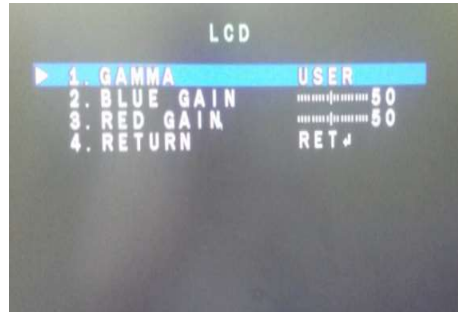

FUNCTION	OPTION	DESCRIPTION
GAMMA	USER,0.45,0.50,0.55,0.60,0.65,0.70,0.75,0.80,0.85,0.90,0.95,1.0	Selects the camma curve
BLUE GAIN	0~100	Adjusts the B-GAIN
RED GAIN	0~100	Adjusts the R-GAIN



■ MONITOR(CRT) "▲" "▼" "◀" "▶" "ⓔ"



FUNCTION	OPTION	DESCRIPTION
BLUE GAIN	0~100	Adjusts the B-GAIN
RED GAIN	0~100	Adjusts the R-GAIN

◆ EXIT

▶ EXIT "◀" "▶" "ⓔ"



FUNCTION	OPTION	DESCRIPTION
EXIT	SAVE&END	The function is used to save the various settings of the internal OSD menu
	RESET	The function initializes all the internal OSD menu settings
	NOT SAVE	The function is used to cancel the current OSD menu settings

◆ Factory Menu Setting

▶ ADJUST "◀"(4sec)



Push the Left key for 4 seconds in the ADJUST position. after 4 seconds, all menu data except the Language and the NTSC,PAL are saved as factory default values.



3. UART Protocol

Not support



4. Packing Information

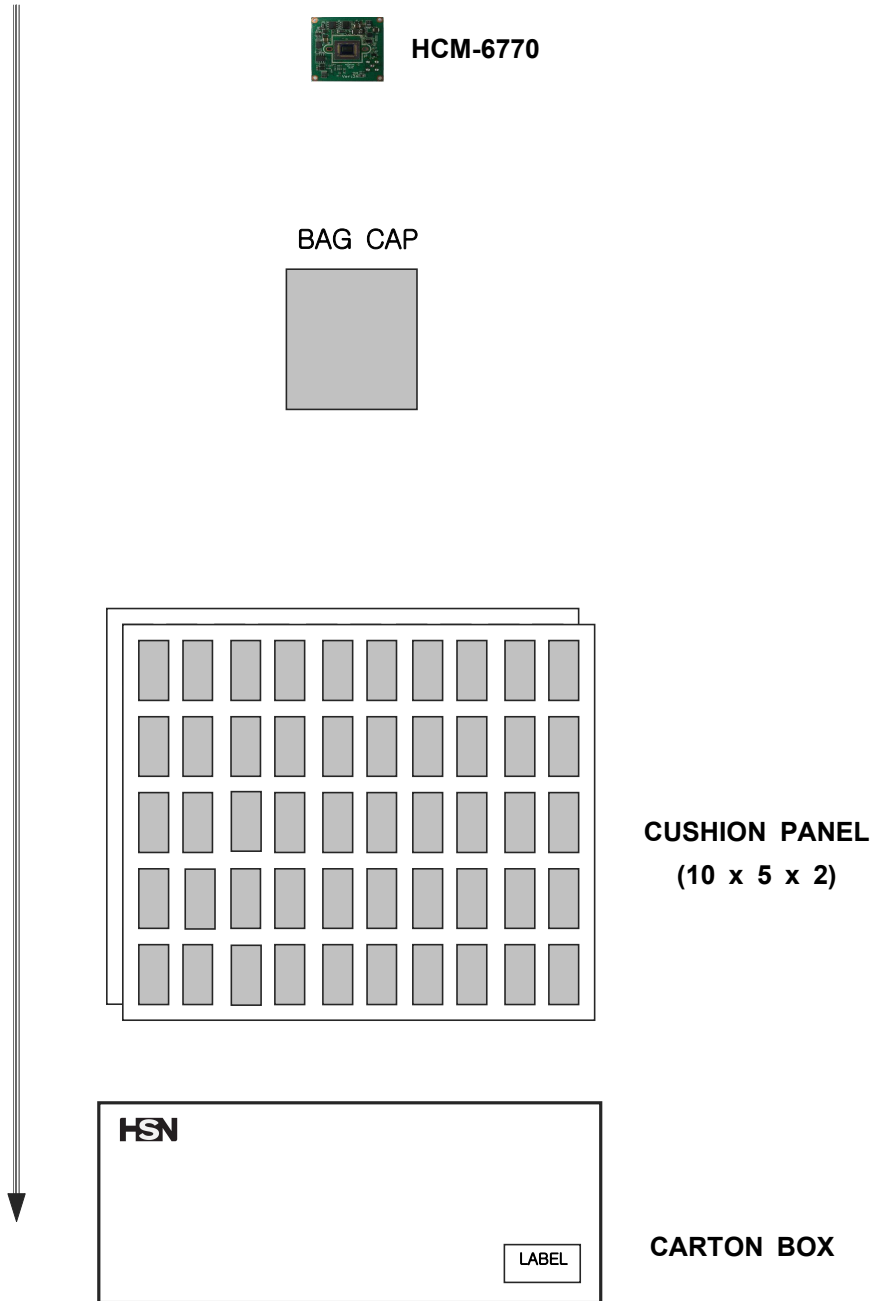



5. Reference Data Sheet

5-1. OLPF(Optical Low Pass Filter) Specifications

5-1-1. OLPF for general lens-1(OLPF Manufacturer : KDS)

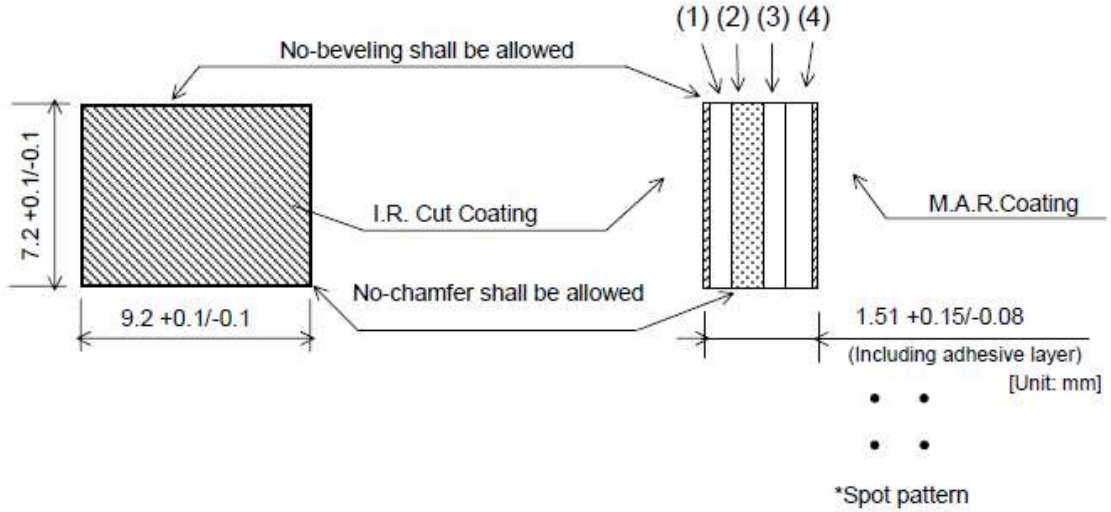

No.	Item	Thickness (mm)	Orientation (degree)	Rotating Angle (degree)	Note
(1)	Double Refraction Plate	0.31 +0.02/-0.01	45 +1/-1	0 +1/-1	
(2)	Infrared Absorbing Glass	0.54 +0.03/-0.03	-	-	C5000(HOYA) or NF50(AGC)
(3)	Wave Plate	0.35 +0.03/-0.03	0 +1/-1	45 +1/-1	
(4)	Double Refraction Plate	0.31 +0.02/-0.01	45 +1/-1	90 +1/-1	

*Rotating angle of parts No. (3) is possible event by -45 +1/-1 degree.

Wavelength (nm)	400-450	450-500	500-550	655+15/-15	720-750	750-1050	1050-1100
Transmission Rate (%)	83min.(Avg.)	87min.(Avg.)	84min.(Avg.)	50	3max.	1max.(Avg.)	5max.
Ripple (%)	73min.	82min.	79min.	-	-	2max.	-

(Spectral characteristics of Optical Low Pass Filter)



5-1-2. OLPF for general lens-2(OLPF Manufacturer : Max Gain)

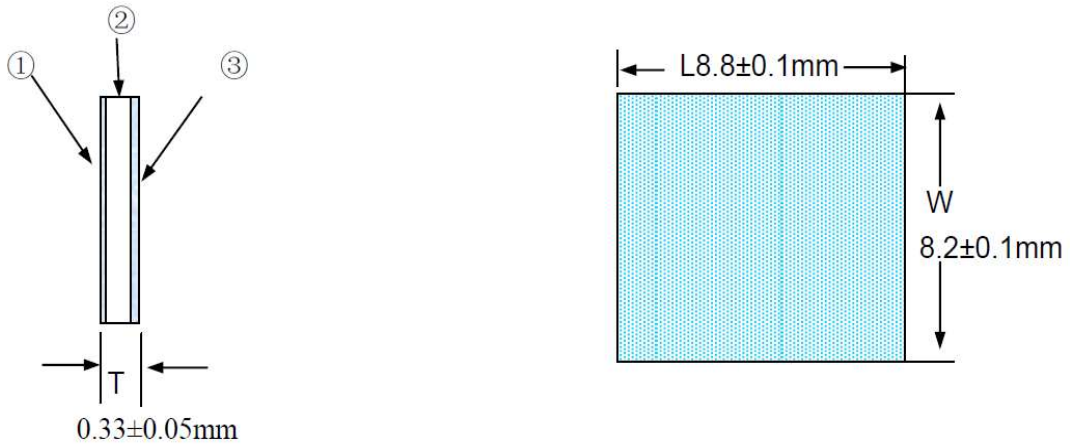

Part No	Part Name	Dimension(mm)			Orientation Angle	Rotation Angle	Flatness	Para.
		L	W	T				
①	IR Coating							
②	Double refractive	8.8±0.	8.2±0.	0.33±0.0	45	0	3N	2'
③	AR Coating							

Wave Length(nm)	Transmission (%)
400nm	>75%
450~600nm	>80%
645 ± 10nm	=50%
700nm	<5%
1100nm	<15%

5-1-3. OLPF for TDN lens(OLPF Manufacturer : Max Gain)

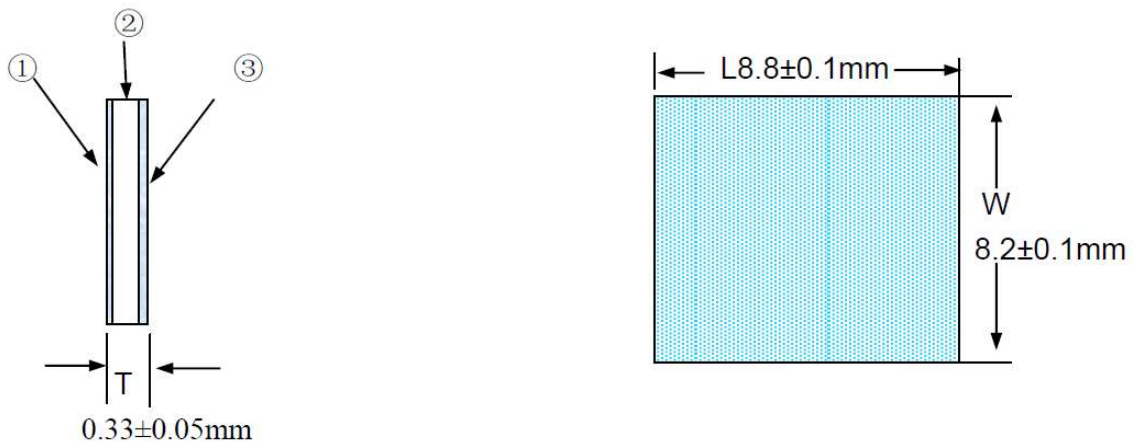



Part No	Part Name	Dimension(mm)			Orientation Angle	Rotation Angle	Flatness	Para
		L	W	T				
①	AR Coating							
②	Double refractive	8.8±0.	8.2±0.	0.33±0.0	45	0	3N	2'
③	AR Coating							

Wave Length(nm)	Transmission (%)
420~1100nm	>96%

5-1-4. OLPF for Night Vision(OLPF Manufacturer : Max Gain)

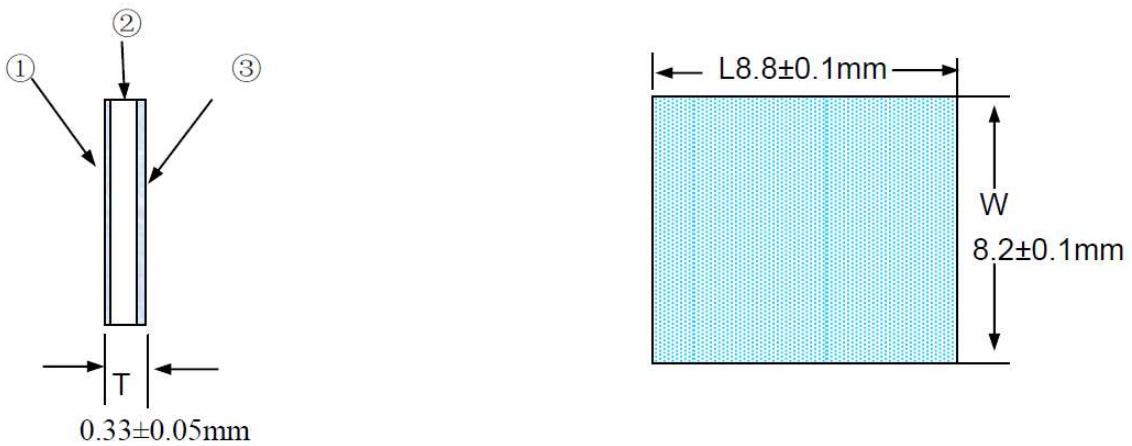

Part No	Part Name	Dimension(mm)			Orientation Angle	Rotation Angle	Flatness	Para
		L	W	T				
①	Night vision Coating							
②	Double refractive	8.8±0.	8.2±0.	0.33±0.0	45	0	3N	2'
③	AR Coating							

Wave Length(nm)	Transmission (%)
400-420	>75%
421-620	>85%
645±10	50%
700-750	<3%
815±15	50%
850	>80%
900-1100	<20%



5-2. I/O Connector Specifications

5-2-1. 12505WS-XXA00 Series

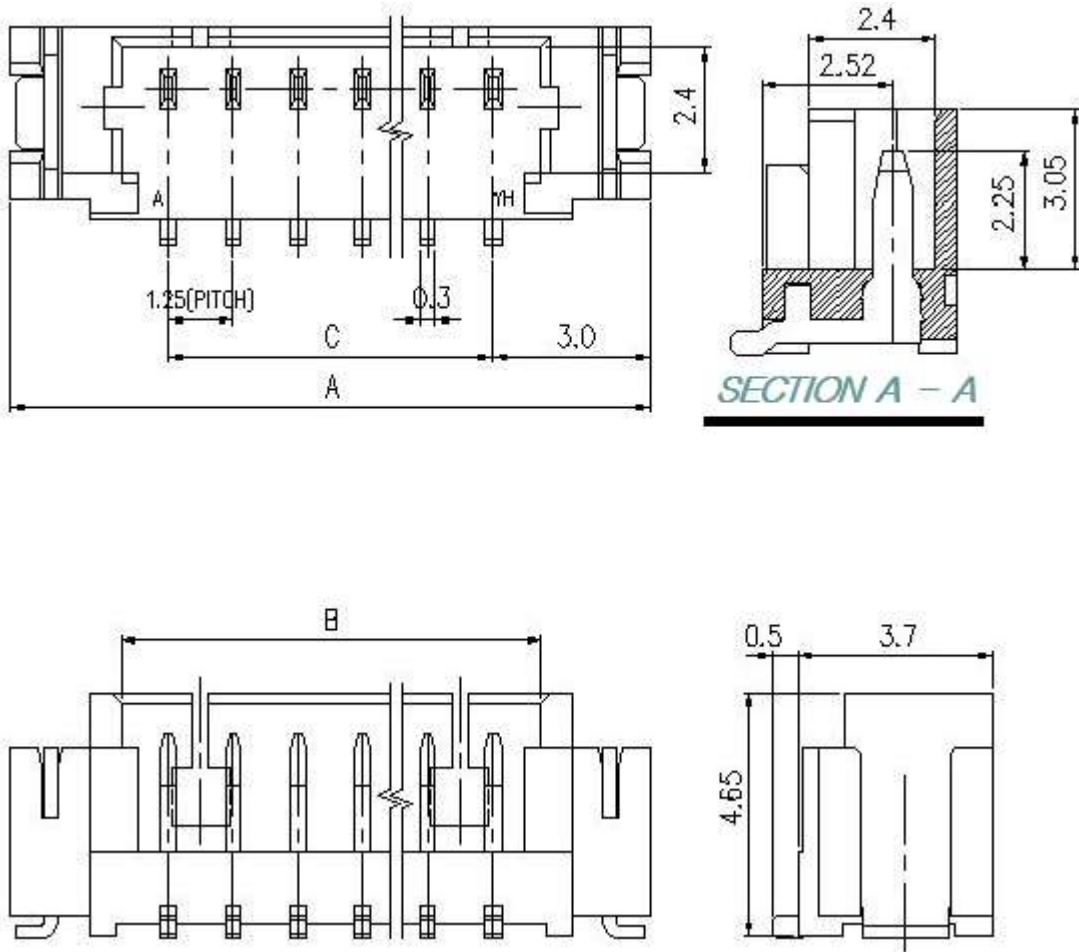

Available Pin

PARTS NO.	A	B	C
12505WS-02	7.25	3.05	-
12505WS-03	8.50	4.30	2.50
12505WS-04	9.75	5.55	3.75
12505WS-05	11.00	6.80	5.00
12505WS-06	12.25	8.05	6.25
12505WS-07	13.50	9.30	7.50
12505WS-08	14.75	10.55	8.75
12505WS-09	16.00	11.80	10.00
12505WS-10	17.25	13.05	11.25
12505WS-11	18.50	14.30	12.50
12505WS-12	19.75	15.55	13.75
12505WS-13	21.00	16.80	15.00
12505WS-14	22.25	18.05	16.25
12505WS-15	23.50	19.30	17.50

Specification

ITEM	SPEC
Voltage Rating	AC/DC 125V
Current Rating	AC/DC 1A
Operating Temperature	-25°C ~ +85°C
Contact Resistance	30mΩ MAX
Withstanding Voltage	AC250V/1min
Insulation Resistance	100MΩ MIN
Applicable Wire	-
Applicable P.C.B	0.8 ~ 1.6mm
Applicable FPC/FFC	-
Solder Height	0.15mm
Crimp Tensile Strength	-
UL FILE NO	E108706



6. Ordering Information(Model Configuration)

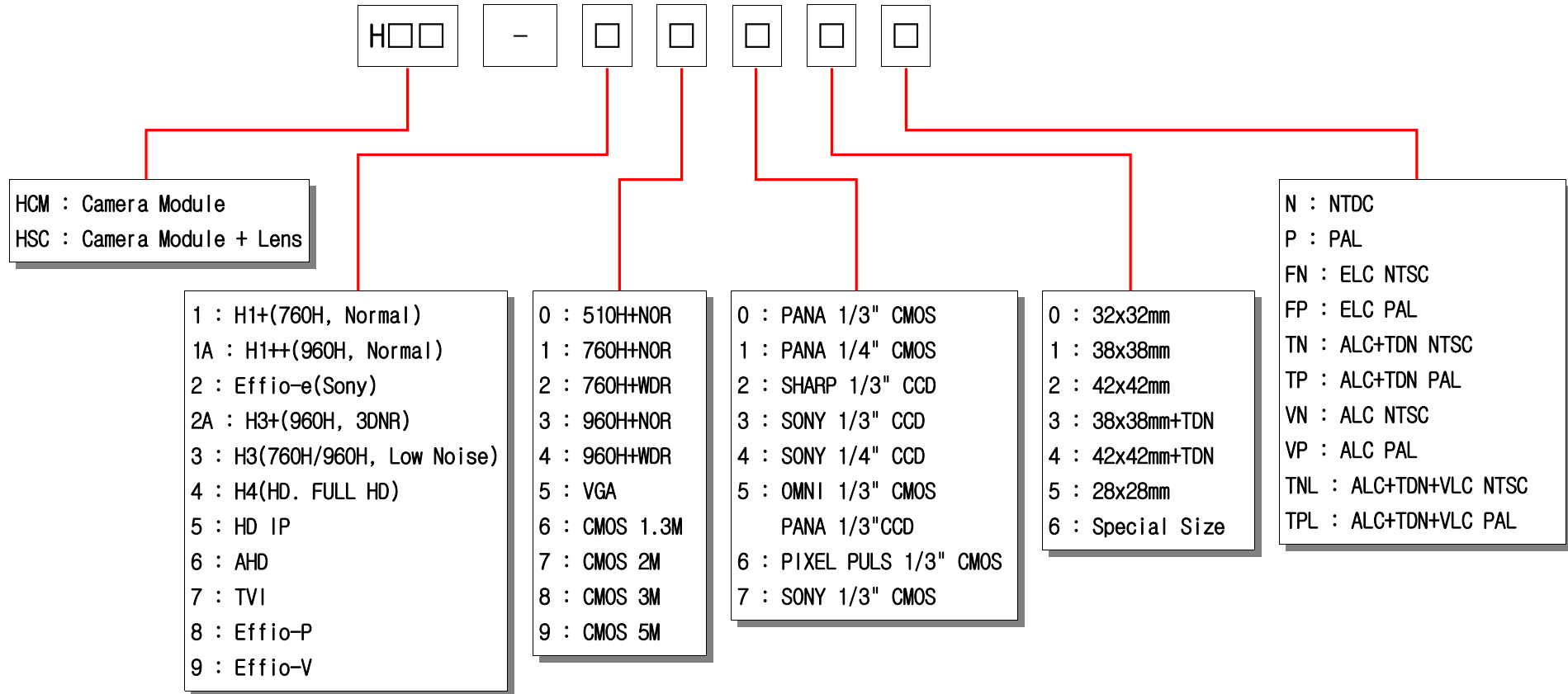

ex) HCM-6770TN : Camera Module / ADH / CMOS 2M / SONY 1/3" CMOS / 32x32mm / ALC TDN NTSC(30fps)
 HCM-9432TP : Camera Module / effio-V / 960H+WDR / SONY 1/3" CCD / 42x42mm / ALC TDN PAL(25fps)
 HCM-2A330FN : Camera Module / H3+ / 960H+NOR / SONY 1/3" CCD / 32x32mm / ELC NTSC(30fps)
 HSC-9432TN : Camera Module + OLPF + Veri Focal Lens(TDN) / effio-V / 960H+WDR / SONY 1/3" CCD / 42x42mm / ALC TDN NTSC(30fps)