



|                    |                    |
|--------------------|--------------------|
| <b>CUSTOMER</b>    |                    |
| <b>ATTENTION 1</b> | <b>2 Mega CMOS</b> |
| <b>ATTENTION 2</b> | <b>32x32mm</b>     |
| <b>MODEL</b>       | <b>HCM-6720FN</b>  |
| <b>CODE NO</b>     |                    |

Color Camera Module

# SPECIFICATIONS

AUG. 24. 2016

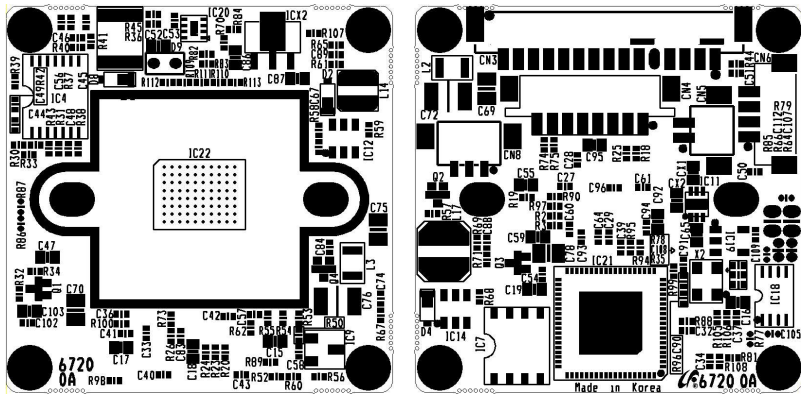

P&A Corporation



# Table of Contents

- Revision History

|   |    |
|---|----|
| <b>1. Features</b> .....                                  | 4  |
| <b>2. Applications &amp; Information</b>                  |    |
| 2-1. General Specifications & Functions .....             | 5  |
| 2-2. Block Diagram .....                                  | 6  |
| 2-3. I/O Interface Specifications                         |    |
| 2-3-1. I/O Circuit .....                                  | 7  |
| 2-3-2. I/O Specifications .....                           | 8  |
| 2-3-3. ADC Key .....                                      | 10 |
| 2-3-4. PCB Layout .....                                   | 11 |
| 2-4. PCB Outline Dimensions .....                         | 12 |
| 2-5. OSD Menu tree .....                                  | 13 |
| 2-6. OSD Menu Functions .....                             | 15 |
| <b>3. UART Protocol</b> .....                             | 28 |
| <b>4. Packing Information</b> .....                       | 39 |
| <b>5. Reference Data Sheet</b>                            |    |
| 5-1. OLPF( Optical Low Pass Filter ) Specifications ..... | 40 |
| 5-1-1. OLPF for general lens .....                        | 40 |
| 5-1-2. OLPF for general lens-2 .....                      | 41 |
| 5-1-3. OLPF for TDN lens .....                            | 41 |
| 5-1-4. OLPF for Night Vision .....                        | 42 |
| 5-2. I/O Connector Specifications .....                   | 43 |



**- Revision History**

| <b>Date</b> | <b>Version</b> | <b>Description</b> |
|-------------|----------------|--------------------|
| AUG.24 2016 | 0A             | Establishment      |



## 1. Features

### ■ 1/3" IMX323LQN 2MEGA SONY CMOS

High definition 12-bit digital image signals offering 2 mega pixels are obtained with high speed of 30 fps and with low power consumption.

### ■ High Resolution 1100(Color)/(BW) TV Lines

This camera has realized high resolution of **1100(Color)/(BW)** TV lines using the top-notch full digital image processing, **12 Bit A/D** serial signal processing and special algorithm technologies.

### ■ DNR (Digital Noise Reduction, 2D+3D)

The DNR technology eliminates noise thus generating a distinct and clear image.

This camera DNR function utilizes both an enhanced 2D filter reducing noise in the brightness of the image and an enhanced 3D filter reducing caused by movement.

### ■ DAY&NIGHT (Output the Filter changing signal)

This camera has the Day&Night function which outputs the filter changing signal with detecting the illumination condition. Day&Night operation feature an 'auto' mode which switches between day and night mode automatically based upon the level of illumination on the scene.

EXTERN mode changes between day and night operation upon triggering from an external source(Optional). And also, the COLOR mode operates in daytime conditions to provide optimum colors, and B/W mode operates in night-time conditions to enhance the definition of the image.

### ■ OSD (On Screen Display)

This camera supports the OSD function which is used with multi language. And so, the camera can be controlled by selecting text displayed on the monitor screen.

### ■ Privacy Mask Function

Privacy masking allows for the 'blinking' of specific areas of a scene, where the viewing or recording of images is prohibited or undesired.

The technology of this camera allows for the user defined setting of a four point polygonal mask, which is overlaid onto the video signal output.

### ■ AHD Analog HD video

HCM-6770TN is a video D/A solution for converting HD digital video signal into the analog domain that is suitable for transmission over signal coax-cable over long reach.

The major application is the security surveillance applications require transmission of HD video.



## 2. Applications & Information

### 2-1. General Specifications & Functions

| Items                 | Sub-items                      | HCM-6720FN   |
|-----------------------|--------------------------------|--|
| CMOS                  | Device                         | 1/3 2MEGA CMOS   |
|                       | Total                          | 2000(H) × 1241(V)  |
|                       | Effective                      | 1984(H) x 1097 (V)   |
| Performance           | Horizontal/Verical Resolution  | 1080p  |
|                       | Minimum illumination(F1.2)     | Color : 0.1 Lux(50IRE) / 0.02 Lux(15IRE)<br>B/W : 0.08 Lux(50IRE) / 0.002 Lux(15IRE)               |
|                       | S/N Ratio                      | More than 50dB (AGC off)   |
|                       | Frame                          | 30fps Full HD  |
| Functions             | OSD                            | English/Chinese(S)/Chinese/German/Francais/Italian/Spanish/Polish/Russian/Portuguese/Dutch/Turkish |
|                       | Day&Night                      | Auto/Color/B&W/EXTERN  |
|                       | ATW                            | 1800 ~ 10500K  |
|                       | High Speed Shutter             | 1/30(1/25) ~ 1/50Ksec  |
|                       | WDR                            | N/A  |
|                       | D-WDR                          | Off/ON/Auto  |
|                       | BLC                            | Size, Position, Level  |
|                       | HSBLC                          | Size, Position, Level, Mode  |
|                       | AGC                            | Level Setting(0~15)  |
|                       | D-Zoom                         | NA   |
|                       | Camera ID                      | Off/On (Letters A to Z, Numerals 0 to 9,   |
|                       | White Balance                  | ATW/AwcSet/Indoor/Outdoor/Manual/AWB   |
|                       | DNR                            | 2D+3DNR, OFF/LOW/MIDDLE/HIGH   |
|                       | Motion Detection               | Off/ON   |
|                       | Privacy Mask                   | 4 Areas (On/Off, Color, Position)  |
|                       | Sens-Up                        | x2,x4,x6,x8,x10,x15,x20,x25,x30  |
|                       | De-Fog                         | Off/AutoI  |
| Etc. Function         | Sharpness, Reverse(H,V)        | 0~10, Freeze,Mirror,Nega.Image   |
|                       | Color Bar                      | N/A  |
|                       | In/Output                      | Alarm Output, Ext IR Mode, IR LED Output   |
|                       | Upstream data                  | VBI data extraction for data communication   |
| Video Output          | Monitor Video Output           | N/A  |
|                       | HD Video Output                | AHD HD video output 1.0Vp-p (75ohm Terminated)   |
| Power Consumption     | DC 12V±10%, Less than 1.8Watts |  |
| Operating Temperature | Absolute : -10°C ~ +50°C       |  |
| Operating Humidity    | Less than 90%                  |  |
| Dimension             | 32mm x 32 mm x 1.0t            |  |



## 2-2. Block Diagram

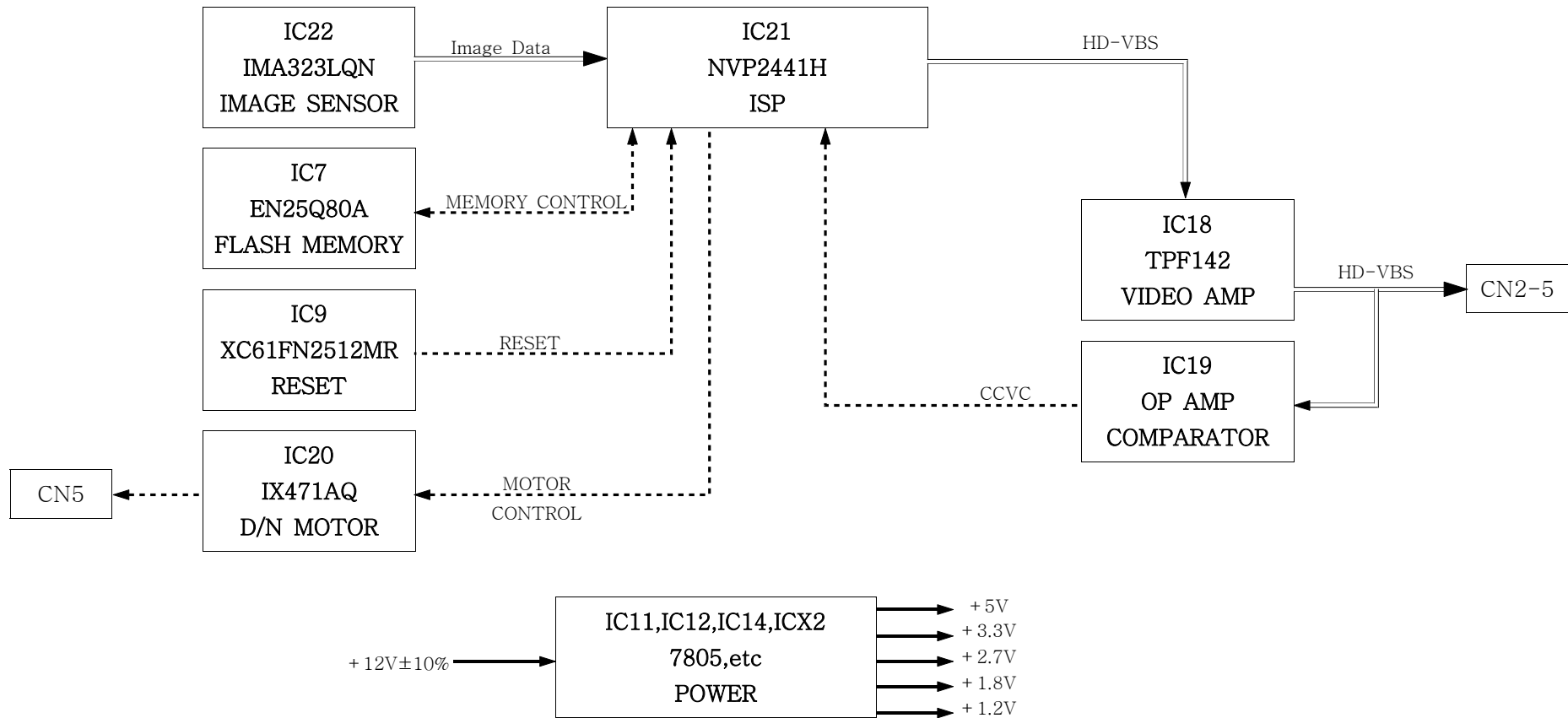



## 2-3. I/O Interface Specifications

### 2-3-1. I/O Circuit

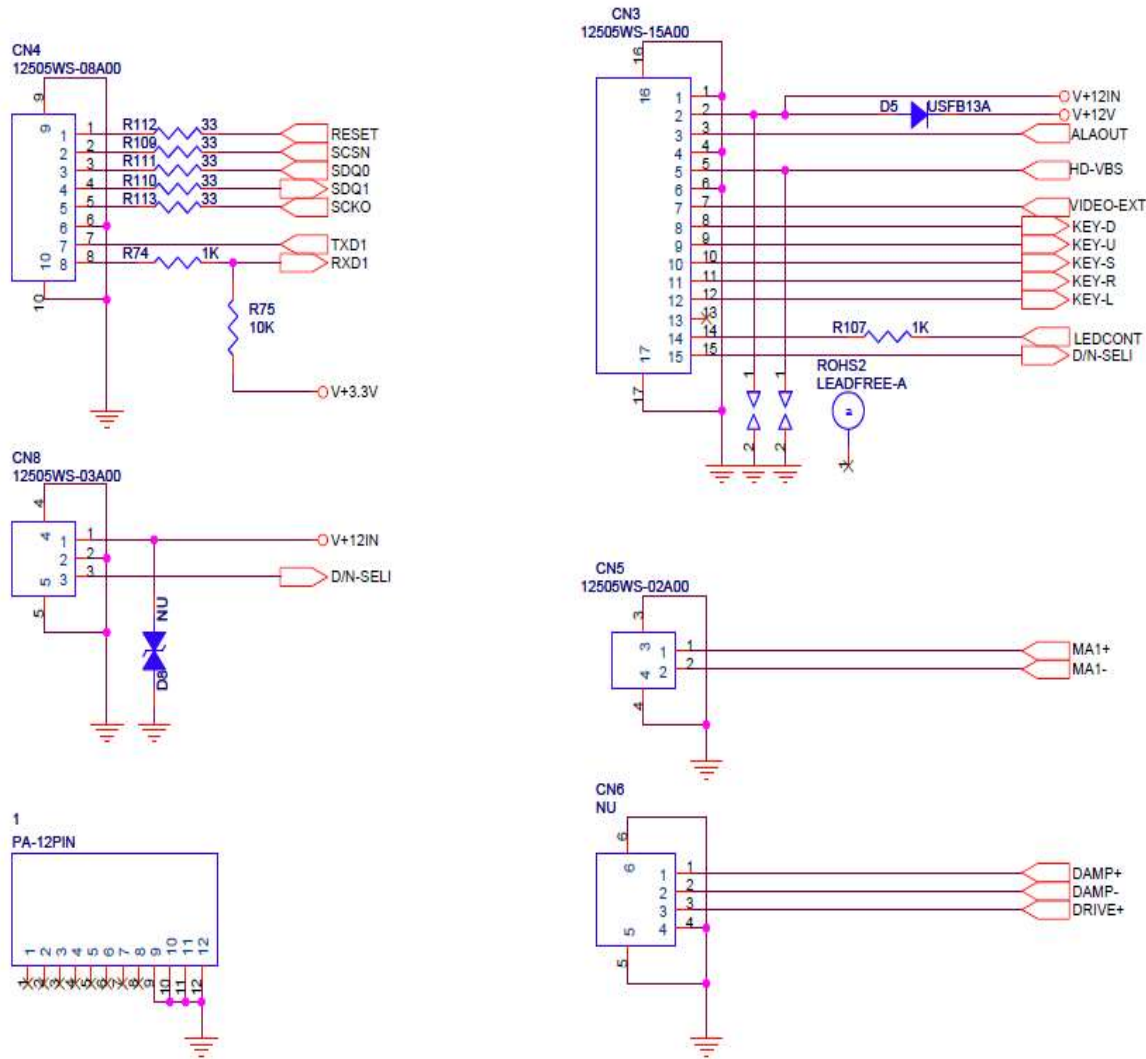



## 2-3-2. I/O Specifications

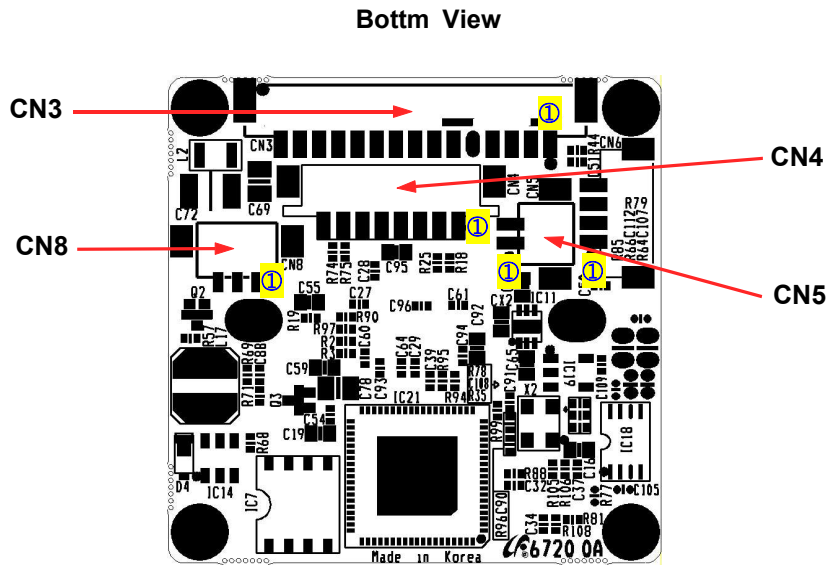

① CN3 : I/O Connector -1

| Pin NO                            | Pin Name | Description                       | Normal     | Active | I/O |
|-----------------------------------|----------|-----------------------------------|------------|--------|-----|
| 1                                 | GND      | Board Ground                      | -          | -      | -   |
| 2                                 | V+12V    | DC+12V Input                      | DC+12V     | DC+12V | I   |
| 3                                 | ALAOUT   | Alarm Output                      | Open       | 0V     | O   |
| 4                                 | GND      | Board Ground                      | -          | -      | -   |
| 5                                 | HD-VBS   | TVI HD Composite Video Output     | 1Vp-p      | 1Vp-p  | O   |
| 6                                 | GND      | Board Ground                      | -          | -      | -   |
| 7                                 | NC       | -                                 | -          | -      | -   |
| 8                                 | KEY-D    | OSD Control DOWN                  | 3.3V       | 0V     | I   |
| 9                                 | KEY-U    | OSD Control Up                    | 3.3V       | 0V     | I   |
| 10                                | KEY-S    | ADC KEY INPUT/OSD Control Enter   | 3.3V       | ADC/0V | I   |
| 11                                | KEY-R    | OSD Control RIGHT                 | 3.3V       | 0V     | I   |
| 12                                | KEY-L    | OSD Control LEFT                  | 3.3V       | 0V     | I   |
| 13                                | NC       | -                                 | -          | -      | -   |
| 14                                | LED CONT | Day & Night Control Output        | 0V         | 3.3V   | O   |
| 15                                | D/N-SELI | External Day & Night Select Input | Open(3.3V) | 0V     | I   |
| Yeonho Electronics, 12505WS-15A00 |          |                                   |            |        |     |





② CN4 : Connector for upgrading Camera Program

| Pin NO                            | Pin Name | Description                         | Normal  | Active  | I/O |
|-----------------------------------|----------|-------------------------------------|---------|---------|-----|
| 1                                 | JMODE    | JTAG MODE(0:Program Debug, 1:Nomal) | Open    | 3.3V/0V | I   |
| 2                                 | JTCK     | JTAG CLOCK                          | Open    | 3.3V/0V | I   |
| 3                                 | JTDO     | JTAG DATA OUT                       | Open    | 3.3V/0V | I   |
| 4                                 | JTDI     | JTAG DATA IN                        | Open    | 3.3V/0V | I   |
| 5                                 | JTMS     | JTAG ENABLE                         | Open    | 3.3V/0V | I   |
| 6                                 | GND      | Board Ground                        | -       | -       | -   |
| 7                                 | TXD1     | UART Transmit OUTPUT1(RS232)        | 3.3V/0V | 3.3V/0V | O   |
| 8                                 | RXD1     | UART Receive INPUT1(RS232)          | 0V      | 3.3V/0V | I   |
| Yeonho Electronics, 12505WS-08A00 |          |                                     |         |         |     |

③ CN5 : Day & Night Motor Control Connector

| Pin NO                            | Pin Name | Description                      | Normal | Active | I/O |
|-----------------------------------|----------|----------------------------------|--------|--------|-----|
| 1                                 | MA+      | Day & Night Motor Drive - Output | Open   | 0V/5V  | O   |
| 2                                 | MA-      | Day & Night Motor Drive + Output | Open   | 5V/0V  | O   |
| Yeonho Electronics, 12505WS-02A00 |          |                                  |        |        |     |

⑤ CN8 : Extra DC+12V & Analog VBS Output

| Pin NO                            | Pin Name | Description                           | Normal     | Active | I/O |
|-----------------------------------|----------|---------------------------------------|------------|--------|-----|
| 1                                 | V+12V    | Extra DC+12V Output(Use IR LED Board) | DC+12V     | DC+12V | O   |
| 2                                 | GND      | Board GROUND                          | -          | -      | -   |
| 3                                 | D/N-SELI | External Day & Night Select Input     | Open(3.3V) | 0V     | I   |
| Yeonho Electronics, 12505WS-03A00 |          |                                       |            |        |     |



## 2-3-3. ADC KEY

### ① KEY-VOLTAGE

| net Name | Direction | Key Name      | Voltage |
|----------|-----------|---------------|---------|
| KEY-S    | ⊙         | SELECT(ENTER) | 0.00V   |
| KEY-U    | ▲         | UP            | 0.66V   |
| KEY-D    | ▼         | DOWN          | 1.21V   |
| KEY-L    | ◀         | LEFT          | 1.92V   |
| KEY-R    | ▶         | RIGHT         | 2.65V   |

### ② Internal/External Circuit

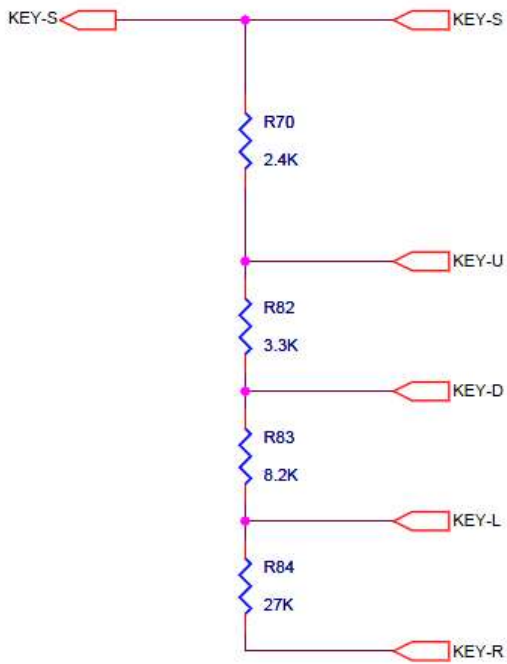

### ③ External Switch(Sample)

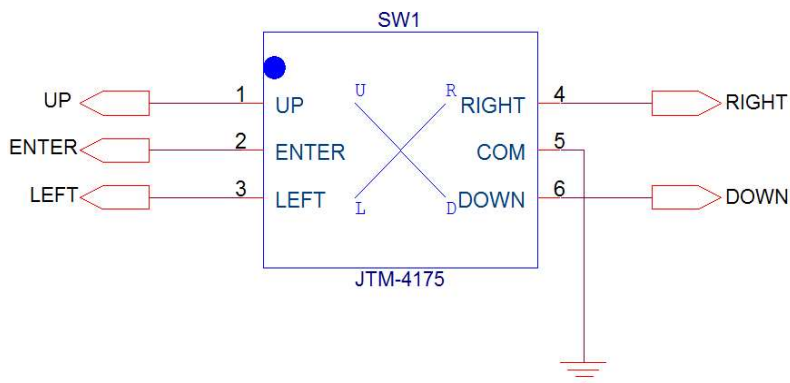





## 2-4. PCB Outline Dimensions

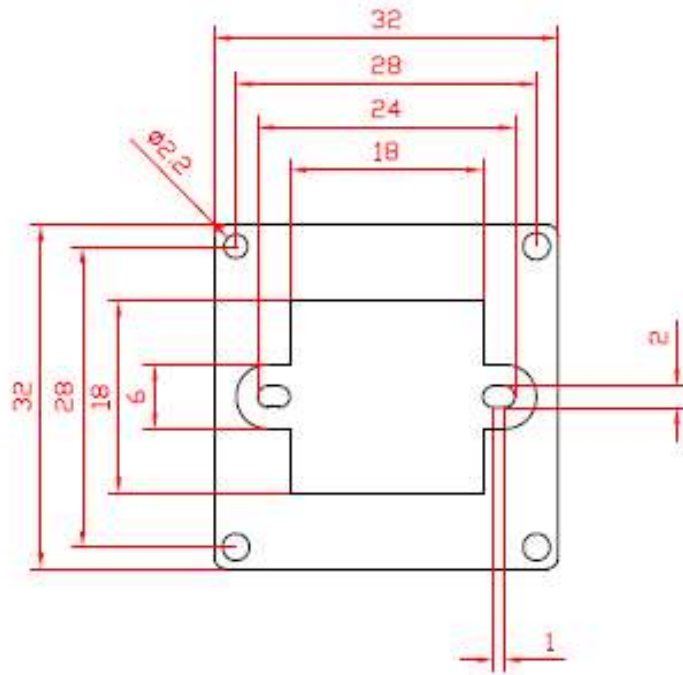

TOP VIEW

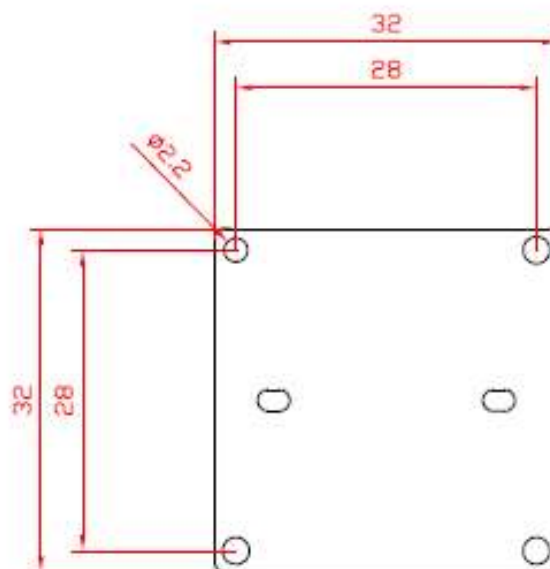

BOTTOM VIEW



## 2-5. OSD Menu tree

| Main Menu | Sub Menu     | Descriptions                           |
|-----------|--------------|--|
| LENS      | -            | DC,MANUAL                              |
|           | MODE         | INDDOR,OUTDOOR                         |
|           | IRIS SPEED   | 0~15                                   |
| EXPOSURE  | SHUTTER      | AUTO,1/30(25)~1/50000,x2~x30           |
|           | AGC          | 0~15                                   |
|           | SENS-UP      | OFF,AUTO(X2~X30)                       |
|           | BRIGHTNESS   | 0~100                                  |
|           | D-WDR        | OFF,ON,AUTO                            |
|           | DEFOG        | OFF,AUTO                               |
| BACKLIGHT | -            | OFF,BLC,HSBLC                          |
|           | LEVEL        | LOW,MIDDLE,HIGH                        |
|           | AREA         | POSITION,SIZE                          |
|           | DEFAULT      | ⓔ                                      |
|           | SELECT       | AREA1~AREA4                            |
|           | DISPLAY      | OFF,ON                                 |
|           | BLACK MASK   | OFF,ON                                 |
|           | LEVEL        | 0~100                                  |
|           | MODE         | NIGHT,ALLDAY                           |
|           | DEFAULT      | ⓔ                                      |
| WHITE BAL | -            | ATW,AWCSET,INDOOR,DOOUTDOOR,MANUAL,AWB |
|           | BLUE         | 0~100                                  |
|           | RED          | 0~100                                  |
| DAY&NIGHT | -            | AUTO,COLOR,B/W,EXT                     |
|           | D->N (AGC)   | 1~255                                  |
|           | D->N (DELAY) | 0~60                                   |
|           | N->D(AGC)    | 1~255                                  |
|           | N->D(DELAY)  | 0~60                                   |
|           | BURST        | OFF,ON                                 |
|           | IR SMART     | OFF,ON                                 |



| Main Menu | Sub Menu  | Descriptions   |
|-----------|-----------|--|
| NR        | 2DNR      | OFF,LOW,MIDDLE,HIGH  |
|           | 3DNR      | OFF,LOW,MIDDLE,HIGH  |
| SPECIAL   | CAM TITLE | OFF,ON   |
|           | D-EFFECT  | FREEZE,MIRROR,NEG.IMAGE  |
|           | MOTION    | OFF,ON   |
|           | PRIVACY   | OFF,ON   |
|           | LANGUAGE  | English/Chinese(S)/Chinese/German/Francais/Italian/Spa<br>nish/Polish/Russian/Portuguese/Dutch/Turkish |
|           | DEFECT    | OFF,ON   |
|           | RS485     | OFF,ON (Not ablable)   |
| ADJUST    | SHARPNESS | OFF,AUTO   |
|           | MONITOR   | LCD,CRT  |
|           | LSC       | OFF,ON   |
|           | VIDEO.OUT | NTSC,PAL   |
| EXIT      | -         | SAVE&END, RESET, NOT SAVE  |



## 2-6 OSD Menu Functions

### ◆ Main Menu



#### ■ LENS

Select the Lens operation type.

#### ■ EXPOSURE

Adjust camera exposure.

#### ■ BACKLIGHT

The function is used to set the Back Light Compensation(BLC) and High Suppress High Light Compensation(HSBLC).

#### ■ WHITE BAL

This function is used to set the White Balance operation which adjusts the color scheme.

#### ■ DAY/NIGHT

The function is used to set the Day/Night function which switches day/Night mode automatically based on the level of illumination.

#### ■ NR

The function is used to reduce the noise using the Digital Noise Reduction (DNR).

#### ■ SPECIAL

The function is used to configure the Motion Detection operation and Alarm function which sense the movement of the scene and cam title, digital effect, privacy, language, defect

#### ■ ADJUST

The function is used to adjust the camera picture(Sharpness, Gamma, Monitor type, lens shading compensation, video format).

#### ■ EXIT

SAVE&END: The function is used to save the various settings of the internal OSD menu.

RESET: The function initializes all the internal OSD menu settings.

NOT SAVE: The function is used to cancel the current OSD menu settings.

### KEY FUNCTIONS

- ▲: Up
- ▼: Down
- ◀: Left
- ▶: Right
- Ⓢ: Enter(Setup)



## ◆ LENS

▶ LENS "◀" "▶" "Ⓜ"



| FUNCTION | OPTION       | DESCRIPTION  |
|----------|--------------|--|
| LENS     | DC<br>MANUAL | DC (Automatic IRIS Control)<br>MANUAL (Electronic Shutter Control) |

■ DC "▲" "▼" "◀" "▶" "Ⓜ"

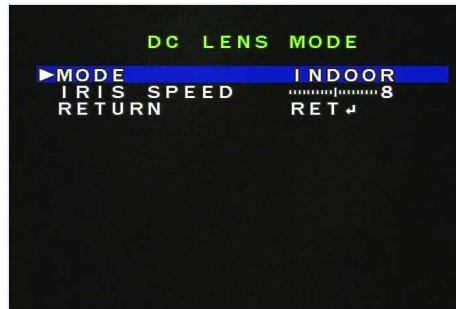

| FUNCTION   | OPTION         | DESCRIPTION                         |
|------------|----------------|-------------------------------------|
| MODE       | INDOOR,OUTDOOR | Selects the auto exposure condition |
| IRIS SPEED | 0~15           | Sets the Iris control speed         |

## ◆ EXPOSURE

▶ EXPOSURE "Ⓜ"



Automatic exposure automatically controls exposure by recognizing the brightness of the object.





■ EXPOSURE "▲" "▼" "◀" "▶" "Ⓜ"

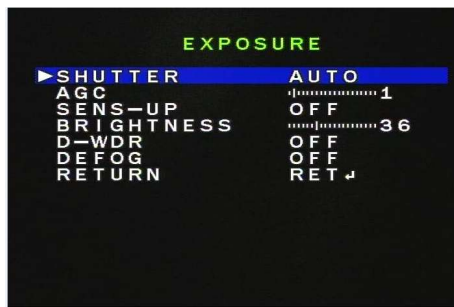

| FUNCTION   | OPTION                               | DESCRIPTION   |
|------------|--------------------------------------|---|
| SHUTTER    | AUTO,<br>1/30(25)~1/50000,<br>x2~x30 | Executes the Shutter speed automatically<br>Executes the user setting high-shutter speed<br>Executes the user setting sens-up speed |
| AGC        | 0~15                                 | Adjusts the agc level   |
| SENS-UP    | OFF,AUTO                             | Sets the sens-up speed  |
| BRIGHTNESS | 0~100                                | Sets the screen brightness  |
| D-WDR      | OFF,ON,AUTO                          | Sets the digital wide dynamic range   |
| DEFOG      | OFF,AUTO                             | Sets the defog  |

■ SENS-UP "▲" "▼" "◀" "▶" "Ⓜ"

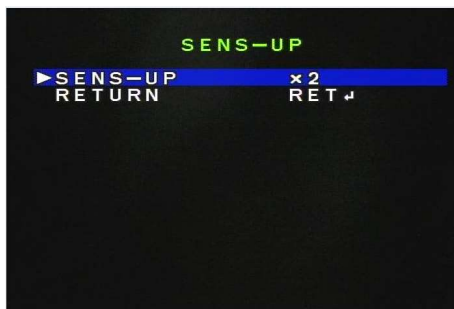

| FUNCTION | OPTION                              | DESCRIPTION               |
|----------|-------------------------------------|---------------------------|
| SENS-UP  | x2,x4,x6,x8,x10,x15,<br>x20,x25,x30 | Adjusts the sens-up speed |

■ D-WDR "▲" "▼" "◀" "▶" "Ⓜ"



| FUNCTION | OPTION | DESCRIPTION              |
|----------|--------|--------------------------|
| LEVEL    | 0~8    | Adjusts the D-WDR weight |



■ DEFOG      "▲" "▼" "◀" "▶" "Ⓜ"



| FUNCTION  | OPTION | DESCRIPTION                    |
|-----------|--------|--------------------------------|
| POS/SIZE  | Ⓜ      | Sets the defog control area    |
| GRADATION | 0~2    | Sets the defog weight          |
| DEFAULT   | Ⓜ      | Initialize the defog condition |

■ POSITION(DEFOG)      "▲" "▼" "◀" "▶" "Ⓜ"

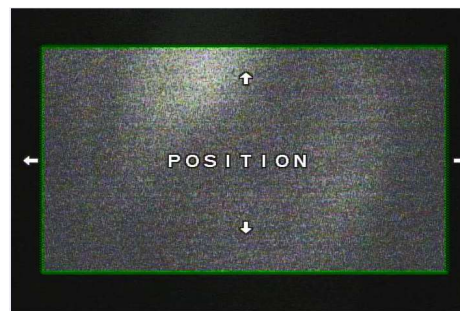

| FUNCTION | OPTION              | DESCRIPTION                     |
|----------|---------------------|---------------------------------|
| POSITION | "▲" "▼" "◀" "▶" "Ⓜ" | Sets position of the defog area |

■ SIZE(DEFOG)      "▲" "▼" "◀" "▶" "Ⓜ"

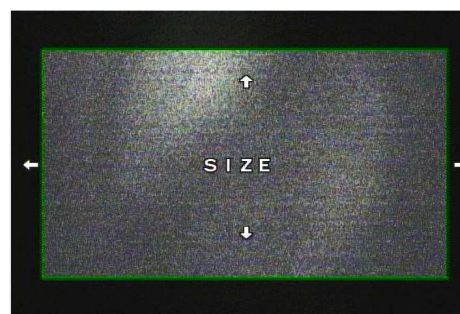

| FUNCTION | OPTION              | DESCRIPTION                 |
|----------|---------------------|-----------------------------|
| SIZE     | "▲" "▼" "◀" "▶" "Ⓜ" | Sets size of the defog area |



■ RET/AGAIN(DEFOG) "▲" "▼" "◀" "▶" "Ⓜ"

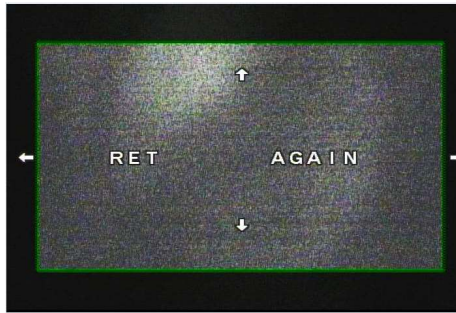

| FUNCTION | OPTION              | DESCRIPTION   |
|----------|---------------------|---|
| RET      | "▲" "▼" "◀" "▶" "Ⓜ" | Completes position set and size set of the defog area |
| AGAIN    | "▲" "▼" "◀" "▶" "Ⓜ" | Retry position set and size set of the defog area     |

◆ BACKLIGHT

▶ BACKLIGHT "◀" "▶" "Ⓜ"



| FUNCTION  | OPTION              | DESCRIPTION   |
|-----------|---------------------|---|
| BACKLIGHT | OFF<br>BLC<br>HSBLC | Off the HLC and HSBLC<br>Use the BLC(Back Light Copensation)<br>Use the HSBLC(High Suppress Back Light Copensation) |

■ BLC "▲" "▼" "◀" "▶" "Ⓜ"



| FUNCTION | OPTION          | DESCRIPTION                  |
|----------|-----------------|------------------------------|
| LEVEL    | LOW,MIDDLE,HIGH | Sets the blc weight          |
| AREA     | Ⓜ               | Sets the blc control area    |
| DEFAULT  | Ⓜ               | Initialize the blc condition |



■ POSITION(BLC)      "▲" "▼" "◀" "▶" "Ⓢ"

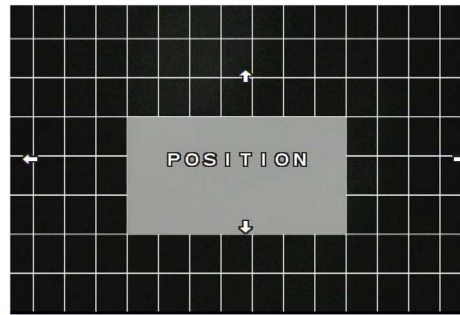

| FUNCTION | OPTION              | DESCRIPTION                           |
|----------|---------------------|---------------------------------------|
| POSITION | "▲" "▼" "◀" "▶" "Ⓢ" | Sets position of the blc control area |

■ SIZE(BLC)      "▲" "▼" "◀" "▶" "Ⓢ"

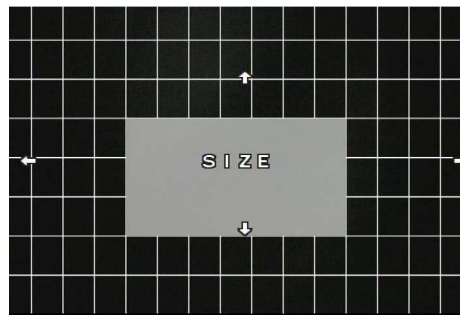

| FUNCTION | OPTION              | DESCRIPTION                       |
|----------|---------------------|-----------------------------------|
| SIZE     | "▲" "▼" "◀" "▶" "Ⓢ" | Sets size of the blc control area |

■ RET/AGAIN(BLC)      "▲" "▼" "◀" "▶" "Ⓢ"

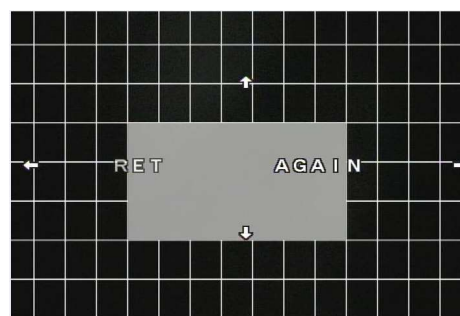

| FUNCTION | OPTION              | DESCRIPTION   |
|----------|---------------------|---|
| RET      | "▲" "▼" "◀" "▶" "Ⓢ" | Completes position set and size set of the blc control area |
| AGAIN    | "▲" "▼" "◀" "▶" "Ⓢ" | Retry position set and size set of the blc control area     |



■ HSBLC "▲" "▼" "◀" "▶" "ⓐ"



| FUNCTION   | OPTION       | DESCRIPTION  |
|------------|--------------|--|
| SELECT     | AREA1~AREA4  | Selects the hsbhc area number                      |
| DISPLAY    | OFF,ON       | Sets the hsbhc control area of the selected number |
| BLACK MASK | OFF,ON       | Sets the mask On or Off                            |
| LEVEL      | 0~100        | Sets the hsbhc weight                              |
| MODE       | NIGHT,ALLDAY | Selects the hsbhc execution condition              |
| DEFAULT    | ⓐ            | Initialize the hsbhc condition                     |

■ POSITION(HSBLC) "▲" "▼" "◀" "▶" "ⓐ"

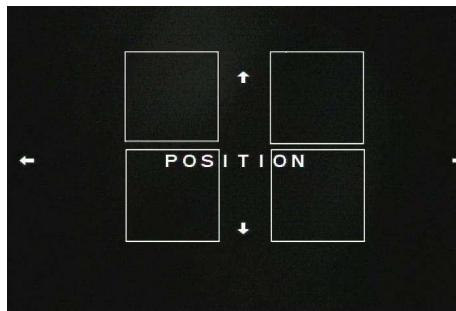

| FUNCTION | OPTION              | DESCRIPTION                             |
|----------|---------------------|---|
| POSITION | "▲" "▼" "◀" "▶" "ⓐ" | Sets position of the hsbhc control area |

■ SIZE(HSBLC) "▲" "▼" "◀" "▶" "ⓐ"

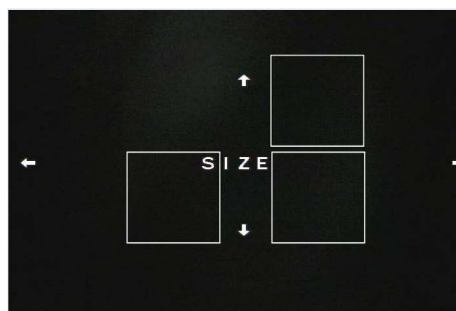



| FUNCTION | OPTION              | DESCRIPTION                         |
|----------|---------------------|-------------------------------------|
| SIZE     | "▲" "▼" "◀" "▶" "Ⓜ" | Sets size of the hsbic control area |

■ **RET/AGAIN(HSBLC)** "▲" "▼" "◀" "▶" "Ⓜ"

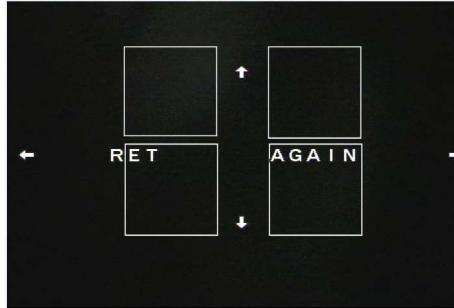

| FUNCTION | OPTION              | DESCRIPTION   |
|----------|---------------------|---|
| RET      | "▲" "▼" "◀" "▶" "Ⓜ" | Completes position set and size set of the hsbic control area |
| AGAIN    | "▲" "▼" "◀" "▶" "Ⓜ" | Retry position set and size set of the hsbic control area     |

■ **NIGHT MODE(HSBLC)** "▲" "▼" "◀" "▶" "Ⓜ"

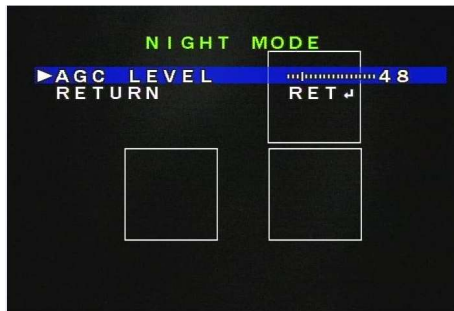

| FUNCTION  | OPTION | DESCRIPTION                                    |
|-----------|--------|--|
| AGC LEVEL | 0~255  | Sets the agc level of the selected area number |

◆ **WHITE BAL**

▶ **WHITE BAL** "◀" "▶" "Ⓜ"





| FUNCTION  | OPTION  | DESCRIPTION   |
|-----------|---------|---|
| WHITE BAL | ATW     | Auto trace white balance  |
|           | AWCSET  | This mode is used to fix the color temperature value            |
|           | INDOOR  | A color temperature is fixed for use in the indoor environment  |
|           | OUTDOOR | A color temperature is fixed for use in the outdoor environment |
|           | MANUAL  | Manual white balance  |
|           | AWB     | auto white balance encompassing all the color temperature space |

■ MANUAL "▲" "▼" "◀" "▶" "Ⓜ"

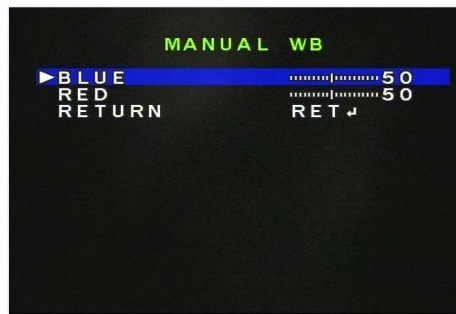

| FUNCTION | OPTION | DESCRIPTION    |
|----------|--------|----------------|
| BLUE     | 0~100  | Adjusts B-GAIN |
| RED      | 0~100  | Adjusts R-GAIN |

## ◆ DAY&NIGHT

▶ DAY/NIGHT "◀" "▶" "Ⓜ"

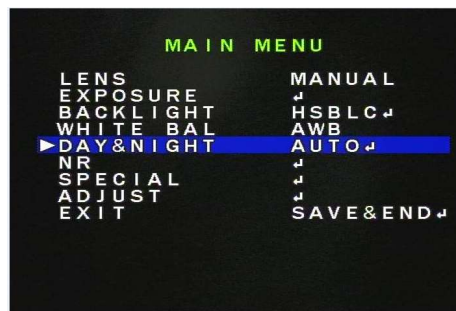

| FUNCTION  | OPTION | DESCRIPTION   |
|-----------|--------|---|
| DAY&NIGHT | AUTO   | switches between day and night mode automatically based upon the level of illumination on the scene |
|           | COLOR  | fixed color   |
|           | B/W    | fixed b/w   |
|           | EXT    | changes between day and night operation upon triggering from an external source                     |



■ AUTO "▲" "▼" "◀" "▶" "Ⓢ"



| FUNCTION    | OPTION | DESCRIPTION                             |
|-------------|--------|---|
| D->N(AGE)   | 1~255  | Sets the day to night thresholded level |
| D->N(DELAY) | 0~60   | Sets the day to night delay time        |
| N->D(AGC)   | 1~255  | Sets the night to day thresholded level |
| N->D(DELAY) | 0~60   | Sets the night to day delay time        |

■ B/W "▲" "▼" "◀" "▶" "Ⓢ"

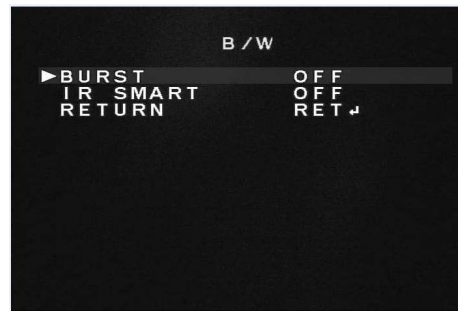

| FUNCTION | OPTION | DESCRIPTION   |
|----------|--------|---|
| BURST    | OFF,ON | Sets the color burst in Night status to On or Off                     |
| IR SMART | OFF,ON | Brightness of IR and saturation phenomenon are automatically adjusted |

■ IR SMART "▲" "▼" "◀" "▶" "Ⓢ"

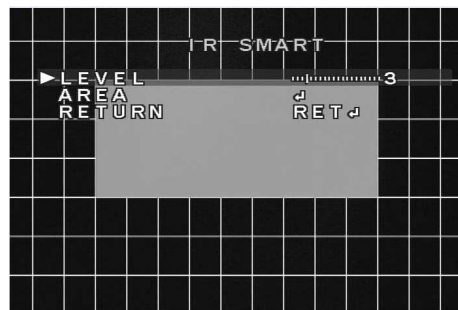

| FUNCTION | OPTION | DESCRIPTION  |
|----------|--------|--|
| LEVEL    | 0~15   | Sets the IR SMART weight                               |
| AREA     | Ⓢ      | Sets the position and the size of the IR SMART control |





■ POSITION(IR SMART)      "▲" "▼" "◀" "▶" "Ⓢ"

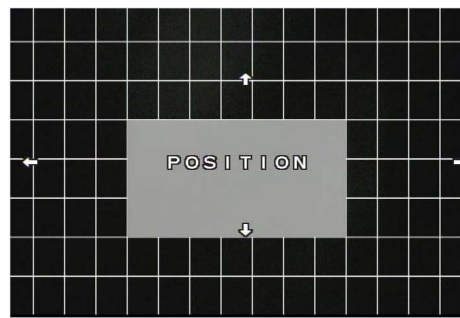

| FUNCTION | OPTION              | DESCRIPTION                                |
|----------|---------------------|--|
| POSITION | "▲" "▼" "◀" "▶" "Ⓢ" | Sets position of the IR SMART control area |

■ SIZE(IR SMART)      "▲" "▼" "◀" "▶" "Ⓢ"

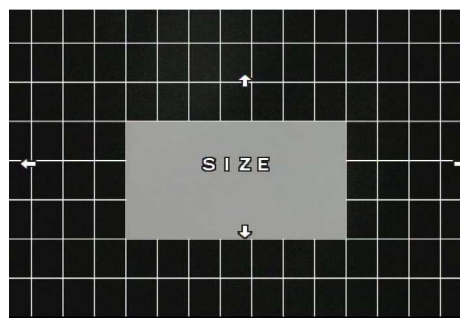

| FUNCTION | OPTION              | DESCRIPTION                            |
|----------|---------------------|--|
| SIZE     | "▲" "▼" "◀" "▶" "Ⓢ" | Sets size of the IR SMART control area |

■ RET/AGAIN(IR SMART)      "▲" "▼" "◀" "▶" "Ⓢ"

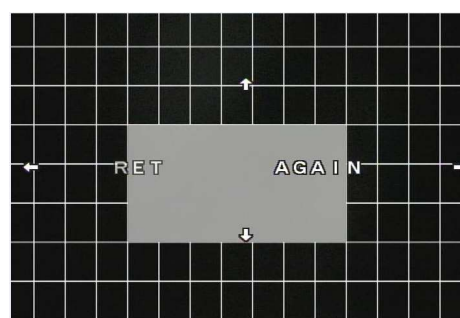

| FUNCTION | OPTION              | DESCRIPTION  |
|----------|---------------------|--|
| RET      | "▲" "▼" "◀" "▶" "Ⓢ" | Completes position set and size set of the IR SMART control area |
| AGAIN    | "▲" "▼" "◀" "▶" "Ⓢ" | Retry position set and size set of the IR SMART control area     |



■ EXT "▲" "▼" "◀" "▶" "Ⓜ"

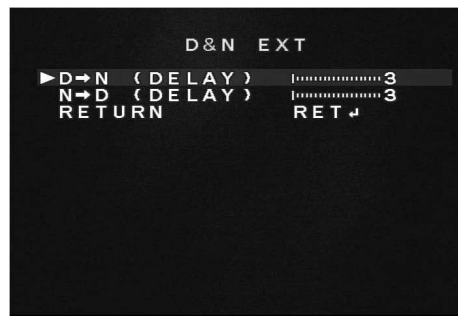

| FUNCTION    | OPTION | DESCRIPTION                      |
|-------------|--------|----------------------------------|
| D->N(DELAY) | 0~60   | Sets the day to night delay time |
| N->D(DELAY) | 0~60   | Sets the night to day delay time |

◆ NR

▶ NR "Ⓜ"



Noise Reduction (NR) is a function to acquire output images of high quality and to enhance compression efficiency.

It provides Edge Preserving 2D NR and Motion Adaptive 3D NR

■ NR "▲" "▼" "◀" "▶" "Ⓜ"

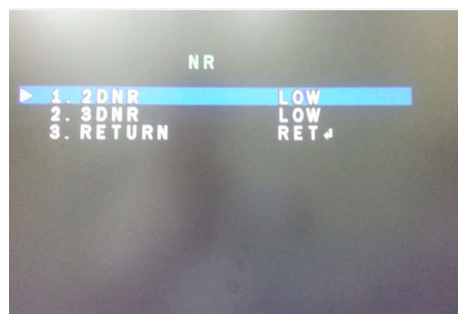

| FUNCTION | OPTION               | DESCRIPTION          |
|----------|----------------------|----------------------|
| 2DNR     | OFF,LOW,MIDDLE, HIGH | Sets the 2DNR weight |
| 3DNR     | OFF,LOW,MIDDLE, HIGH | Sets the 3DNR weight |



## ◆ SPECIAL

▶ SPECIAL "Ⓜ"

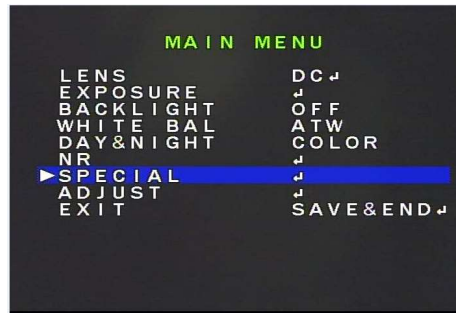

The function is used to configure the Motion Detection operation and Alarm function which sense the movement of the scene and cam title, digital effect, privacy, language, defect

■ SPECIAL "▲" "▼" "◀" "▶" "Ⓜ"



| FUNCTION  | OPTION   | DESCRIPTION                     |
|-----------|--|---------------------------------|
| CAM TITLE | OFF,ON   | Sets the camera title           |
| D-EFFECT  | Ⓜ  | Sets the digital effect item    |
| MOTION    | OFF,ON   | Sets the motion On or Off       |
| PRIVACY   | OFF,ON   | Sets the privacy mask On or Off |
| LANGUAGE  | English/Chinese(S)/Chinese/German/French/Italian/Spanish/Polish/Russian/Portuguese/Dutch/Turkish | Select the languages            |
| DEFECT    | Ⓜ  | Sets the defect compensation    |
| RS485     | Ⓜ  | Sets the RS485 (Not able)       |



■ CAM TITLE "▲" "▼" "◀" "▶" "ⓔ"



Up to 14 letters can be displayed on the screen.

■ D-EFFECT "▲" "▼" "◀" "▶" "ⓔ"



| FUNCTION  | OPTION                       | DESCRIPTION   |
|-----------|------------------------------|---|
| FREEZE    | OFF,ON                       | A still image can be output   |
| MIRROR    | OFF,MIRROR,<br>V-FLIP,ROTATE | The image can be turned upside down, flipped or rotated 180° before print-out |
| NEG.IMAGE | OFF,ON                       | A negative image of the original can be output                                |

■ MOTION "▲" "▼" "◀" "▶" "ⓔ"

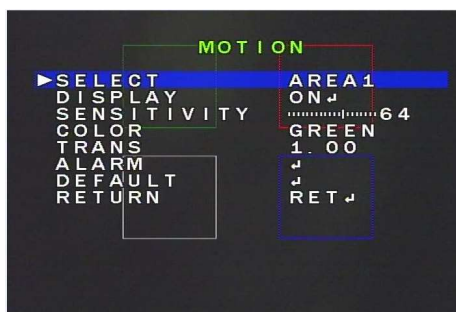

| FUNCTION    | OPTION                   | DESCRIPTION   |
|-------------|--------------------------|---|
| SELECT      | AREA1~AREA4              | Selects the motion control area number              |
| DISPLAY     | OFF,ON                   | Sets the motion control area of the selected number |
| SENSITIVITY | 0~100                    | Sets the motion detection sensitivity               |
| COLOR       | GREEN,BLUE,WHITE,<br>RED | Sets the motion display color                       |
| TRANS       | 0.00, 0.25, 0.75,        | Sets the motion display transparence                |



|         |   |   |
|---------|---|---|
| ALARM   | Ⓜ | Sets the motion alarm display type and alarm port |
| DEFAULT | Ⓜ | Initialize the motion condition                   |

■ POSITION(MOTION) "▲" "▼" "◀" "▶" "Ⓜ"

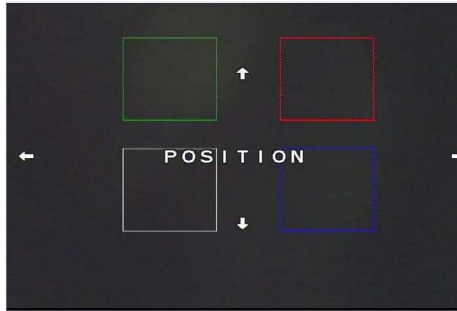

| FUNCTION | OPTION              | DESCRIPTION                              |
|----------|---------------------|--|
| POSITION | "▲" "▼" "◀" "▶" "Ⓜ" | Sets position of the motion control area |

■ SIZE(MOTION) "▲" "▼" "◀" "▶" "Ⓜ"

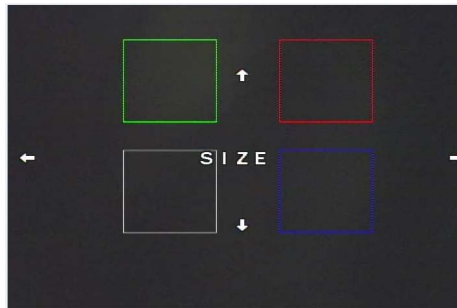

| FUNCTION | OPTION              | DESCRIPTION                          |
|----------|---------------------|--------------------------------------|
| SIZE     | "▲" "▼" "◀" "▶" "Ⓜ" | Sets size of the motion control area |

■ RET/AGAIN(MOTION) "▲" "▼" "◀" "▶" "Ⓜ"

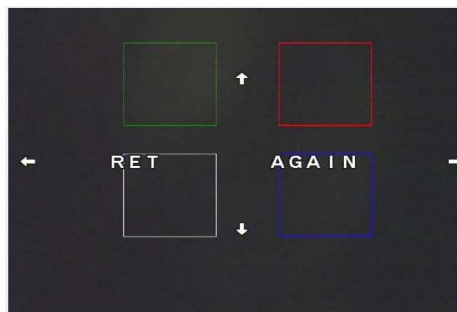



| FUNCTION | OPTION              | DESCRIPTION  |
|----------|---------------------|--|
| RET      | "▲" "▼" "◀" "▶" "ⓔ" | Completes position set and size set of the motion control area |
| AGAIN    | "▲" "▼" "◀" "▶" "ⓔ" | Retry position set and size set of the motion control area     |

■ **ALARM** "▲" "▼" "◀" "▶" "ⓔ"

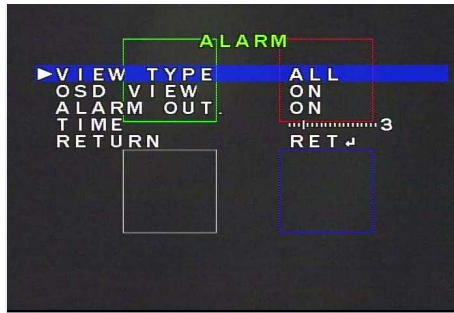

| FUNCTION  | OPTION                 | DESCRIPTION                      |
|-----------|------------------------|----------------------------------|
| VIEW TYPE | OFF,ALL,BLOCK, OUTLINE | Sets the motion display type     |
| OSD VIEW  | OFF,ON                 | Sets the text alarm On or Off    |
| ALARM OUT | OFF,ON                 | Sets the alarm port On or Off    |
| TIME      | 0~3                    | Sets the text alarm display time |

■ **PRIVACY** "▲" "▼" "◀" "▶" "ⓔ"

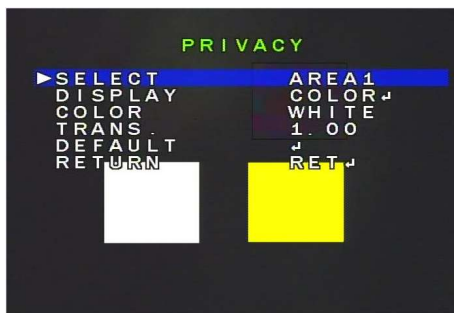

| FUNCTION | OPTION                                      | DESCRIPTION  |
|----------|---|--|
| SELECT   | AREA1~AREA4                                 | Selects the privacy control area number              |
| DISPLAY  | OFF,MOSAIC,INV., COLOR                      | Sets the privacy control area of the selected number |
| COLOR    | RED,BLUE,YELLOW,GREEN,CYAN,USER,WHITE,BLACK | Sets the privacy color                               |
| TRANS    | 0.00, 0.25, 0.50, 0.75, 1.00                | Sets the privacy display transparency                |
| DEFAULT  | ⓔ   | Initialize the privacy condition                     |



■ POSITION(PRIVACY) "▲" "▼" "◀" "▶" "Ⓜ"

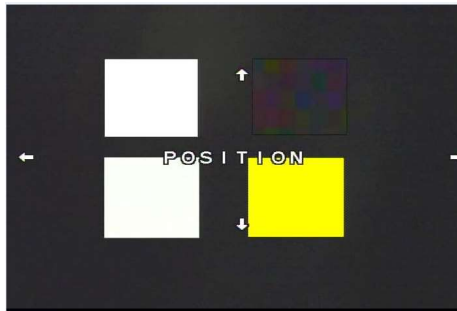

| FUNCTION | OPTION              | DESCRIPTION                               |
|----------|---------------------|---|
| POSITION | "▲" "▼" "◀" "▶" "Ⓜ" | Sets position of the privacy control area |

■ SIZE(PRIVACY) "▲" "▼" "◀" "▶" "Ⓜ"

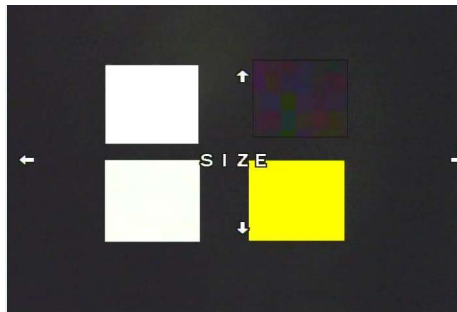

| FUNCTION | OPTION              | DESCRIPTION                           |
|----------|---------------------|---------------------------------------|
| SIZE     | "▲" "▼" "◀" "▶" "Ⓜ" | Sets size of the privacy control area |

■ RET/AGAIN(PRIVACY) "▲" "▼" "◀" "▶" "Ⓜ"

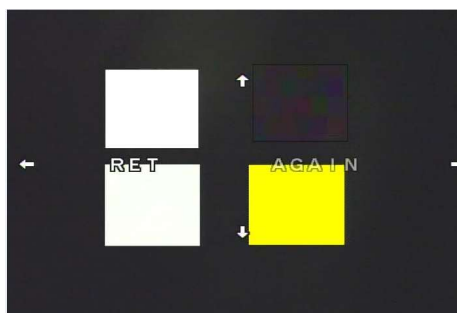

| FUNCTION | OPTION              | DESCRIPTION   |
|----------|---------------------|---|
| RET      | "▲" "▼" "◀" "▶" "Ⓜ" | Completes position set and size set of the privacy control area |
| AGAIN    | "▲" "▼" "◀" "▶" "Ⓜ" | Retry position set and size set of the privacy control area     |



■ DPC      "▲" "▼" "◀" "▶" "Ⓢ"



| FUNCTION  | OPTION | DESCRIPTION   |
|-----------|--------|---|
| LIVE DPC  | OFF,ON | Selects the real time defect compensation On or Off |
| WHITE DPC | OFF,ON | Sets the white defect compensation On or Off        |
| BLACK DPC | OFF,ON | Sets the black defect compensation On or Off        |

■ LIVE DPC      "▲" "▼" "◀" "▶" "Ⓢ"



| FUNCTION  | OPTION | DESCRIPTION  |
|-----------|--------|--|
| AGC LEVEL | 0~255  | Adjusts the illuminance for live defect compensation |
| LEVEL     | 0~255  | Sets the defect compensation weight                  |

■ WHITE DPC      "▲" "▼" "◀" "▶" "Ⓢ"



| FUNCTION | OPTION | DESCRIPTION                          |
|----------|--------|--------------------------------------|
| POS/SIZE | Ⓢ      | Sets the white defect area           |
| START    | Ⓢ      | Starts the white defect adjust       |
| DPC VIEW | OFF,ON | displays the current defect position |





|         |        |  |
|---------|--------|--|
| LEVEL   | 0~100  | Sets the white defect compensation weight          |
| AGC     | 0~14   | Sets the agc level for the white defect adjust     |
| SENS-UP | x2~x30 | Sets the sens-up value for the white defect adjust |

■ POSITION(WHITE DPC)    "▲" "▼" "◀" "▶" "Ⓜ"



| FUNCTION | OPTION              | DESCRIPTION                                    |
|----------|---------------------|--|
| POSITION | "▲" "▼" "◀" "▶" "Ⓜ" | Sets position of the white defect control area |

■ SIZE(WHITE DPC)    "▲" "▼" "◀" "▶" "Ⓜ"



| FUNCTION | OPTION              | DESCRIPTION                                |
|----------|---------------------|--|
| SIZE     | "▲" "▼" "◀" "▶" "Ⓜ" | Sets size of the white defect control area |

■ RET/AGAIN(WHITE DPC)    "▲" "▼" "◀" "▶" "Ⓜ"





| FUNCTION | OPTION                  | DESCRIPTION  |
|----------|-------------------------|--|
| RET      | "▲" "▼" "◀" "▶" "<br>Ⓜ" | Completes position set and size set of the white defect control area |
| AGAIN    | "▲" "▼" "◀" "▶" "<br>Ⓜ" | Retry position set and size set of the white defect control area     |

■ **BLACK DPC** "▲" "▼" "◀" "▶" "Ⓜ"



| FUNCTION | OPTION | DESCRIPTION                               |
|----------|--------|---|
| POS/SIZE | Ⓜ      | Sets the black defect area                |
| START    | Ⓜ      | Start the black defect adjust             |
| DPC VIEW | OFF,ON | displays the current defect position      |
| LEVEL    | 0~100  | Sets the black defect compensation weight |

■ **POSITION(BLACK DPC)** "▲" "▼" "◀" "▶" "Ⓜ"



| FUNCTION | OPTION                  | DESCRIPTION                                    |
|----------|-------------------------|--|
| POSITION | "▲" "▼" "◀" "▶" "<br>Ⓜ" | Sets position of the black defect control area |

■ **SIZE(BLACK DPC)** "▲" "▼" "◀" "▶" "Ⓜ"





| FUNCTION | OPTION              | DESCRIPTION                                |
|----------|---------------------|--|
| SIZE     | "▲" "▼" "◀" "▶" "Ⓜ" | Sets size of the black defect control area |

■ RET/AGAIN(BLACK DPC) "▲" "▼" "◀" "▶" "Ⓜ"



| FUNCTION | OPTION              | DESCRIPTION  |
|----------|---------------------|--|
| RET      | "▲" "▼" "◀" "▶" "Ⓜ" | Completes position set and size set of the black defect control area |
| AGAIN    | "▲" "▼" "◀" "▶" "Ⓜ" | Retry position set and size set of the black defect control area     |

◆ ADJUST

▶ ADJUST "Ⓜ"



The function is used to adjust the camera picture(Sharpness, Gamma, Monitor type,lens shading compensation, video format).

■ ADJUST "▲" "▼" "◀" "▶" "Ⓜ"

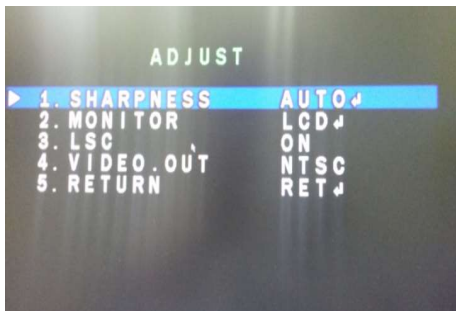



| FUNCTION  | OPTION   | DESCRIPTION                                  |
|-----------|----------|--|
| SHAPNESS  | OFF,AUTO | Adjusts the sharpness                        |
| MONITOR   | LCD,CRT  | Selects the monitor type                     |
| LSC       | OFF,ON   | Sets the lens shading compensation On or Off |
| VIDEO.OUT | NTSC,PAL | Selects the video output format              |

■ SHARPNESS "▲" "▼" "◀" "▶" "Ⓢ"



| FUNCTION  | OPTION | DESCRIPTION                                |
|-----------|--------|--|
| LEVEL     | 0~10   | Sets the sharpness weight                  |
| START AGC | 0~255  | Adjsts the sharpness curve accoding to agc |
| END AGC   | 0~255  | Adjsts the sharpness curve accoding to agc |

■ MONITOR(LCD) "▲" "▼" "◀" "▶" "Ⓢ"

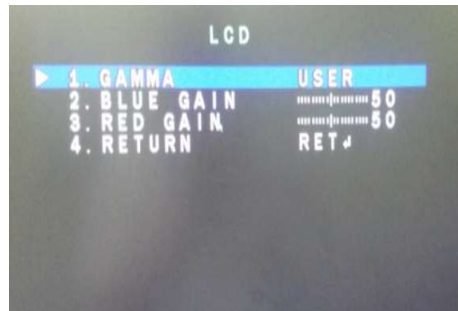

| FUNCTION  | OPTION  | DESCRIPTION             |
|-----------|---|-------------------------|
| GAMMA     | USER,0.45,0.50,0.55,0.60,0.65,0.70,0.75,0.80,0.85,0.90,0.95,1.0 | Selects the camma curve |
| BLUE GAIN | 0~100   | Adjusts the B-GAIN      |
| RED GAIN  | 0~100   | Adjusts the R-GAIN      |



■ MONITOR(CRT) "▲" "▼" "◀" "▶" "ⓔ"



| FUNCTION  | OPTION | DESCRIPTION        |
|-----------|--------|--------------------|
| BLUE GAIN | 0~100  | Adjusts the B-GAIN |
| RED GAIN  | 0~100  | Adjusts the R-GAIN |

◆ EXIT

▶ EXIT "◀" "▶" "ⓔ"



| FUNCTION | OPTION   | DESCRIPTION  |
|----------|----------|--|
| EXIT     | SAVE&END | The function is used to save the various settings of the internal OSD menu |
|          | RESET    | The function initializes all the internal OSD menu settings                |
|          | NOT SAVE | The function is used to cancel the current OSD menu settings               |

◆ Factory Menu Setting

▶ ADJUST "◀"(4sec)



Push the Left key for 4 seconds in the ADJUST position. after 4 seconds, all menu data except the Language and the NTSC,PAL are saved as factory default values.



### **3. UART Protocol**

**Not support**



## 4. Packing Information

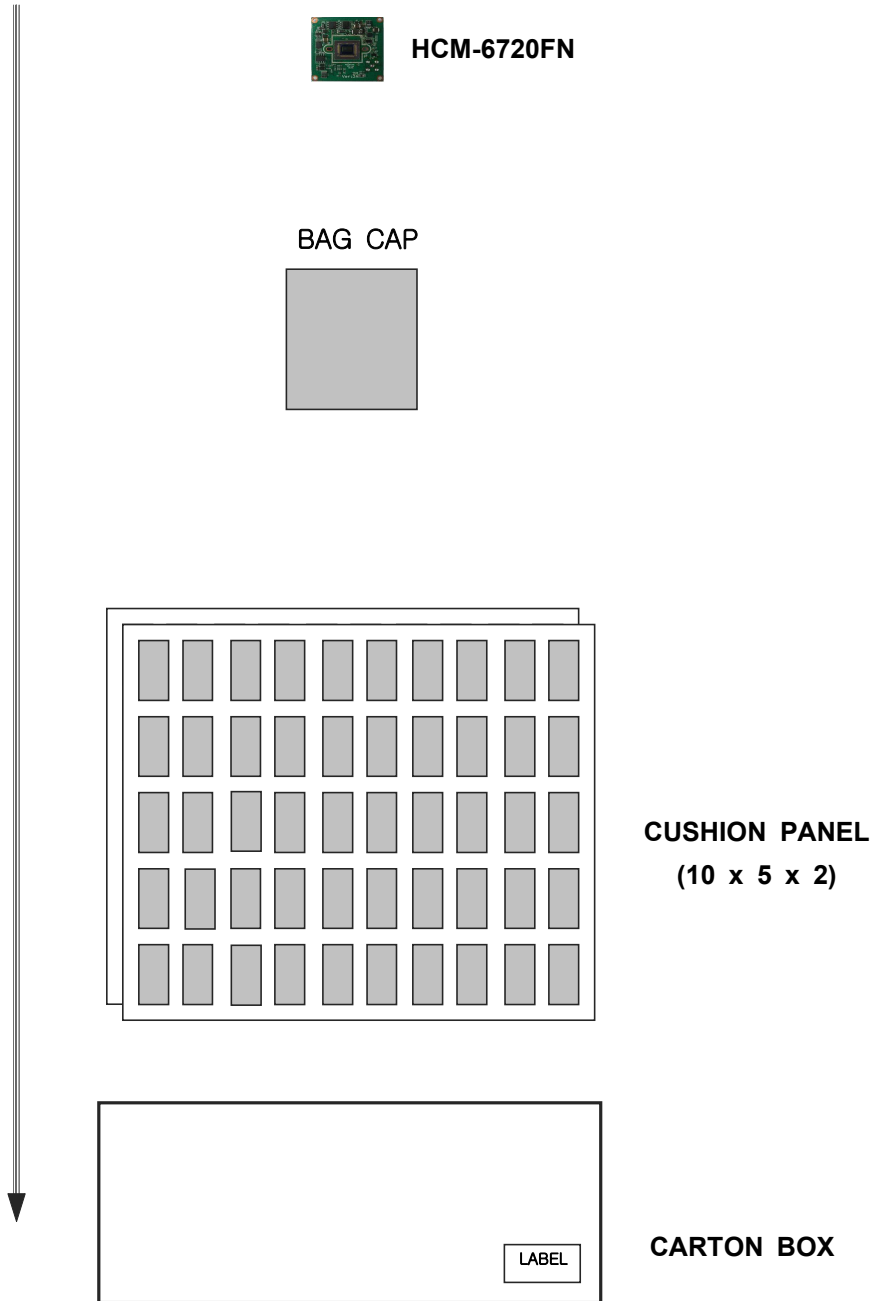



## 5. Reference Data Sheet

### 5-1. OLPF( Optical Low Pass Filter ) Specifications

#### 5-1-1. OLPF for general lens-1(OLPF Manufacturer : KDS)

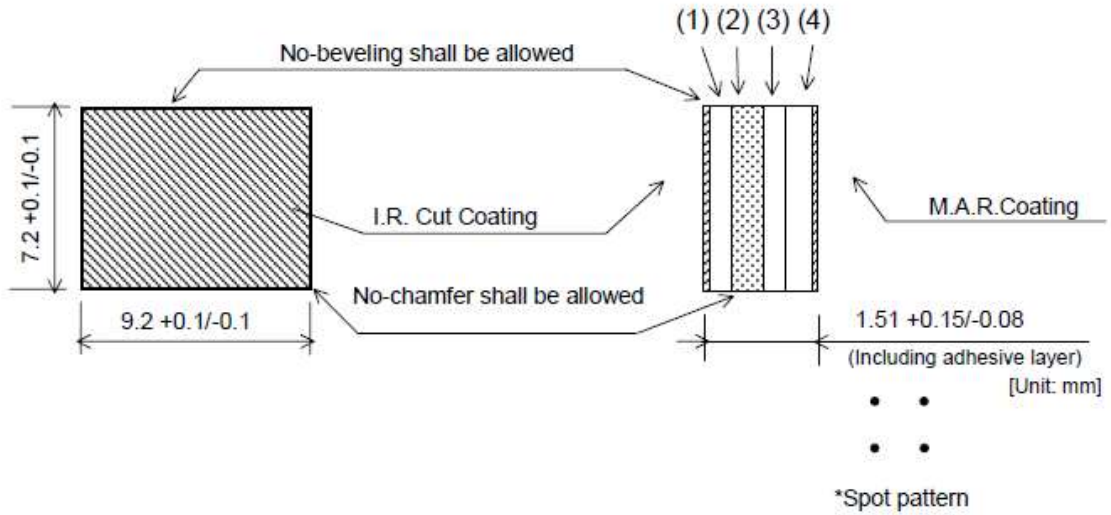

| No. | Item                     | Thickness (mm)   | Orientation (degree) | Rotating Angle (degree) | Note                     |
|-----|--------------------------|------------------|----------------------|-------------------------|--------------------------|
| (1) | Double Refraction Plate  | 0.31 +0.02/-0.01 | 45 +1/-1             | 0 +1/-1                 |                          |
| (2) | Infrared Absorbing Glass | 0.54 +0.03/-0.03 | -                    | -                       | C5000(HOYA) or NF50(AGC) |
| (3) | Wave Plate               | 0.35 +0.03/-0.03 | 0 +1/-1              | 45 +1/-1                |                          |
| (4) | Double Refraction Plate  | 0.31 +0.02/-0.01 | 45 +1/-1             | 90 +1/-1                |                          |

\*Rotating angle of parts No. (3) is possible event by -45 +1/-1 degree.

| Wavelength (nm)       | 400-450      | 450-500      | 500-550      | 655+15/-15 | 720-750 | 750-1050    | 1050-1100 |
|-----------------------|--------------|--------------|--------------|------------|---------|-------------|-----------|
| Transmission Rate (%) | 83min.(Avg.) | 87min.(Avg.) | 84min.(Avg.) | 50         | 3max.   | 1max.(Avg.) | 5max.     |
| Ripple (%)            | 73min.       | 82min.       | 79min.       | -          | -       | 2max.       | -         |

(Spectral characteristics of Optical Low Pass Filter )





### 5-1-2. OLPF for general lens-2(OLPF Manufacturer : Max Gain)

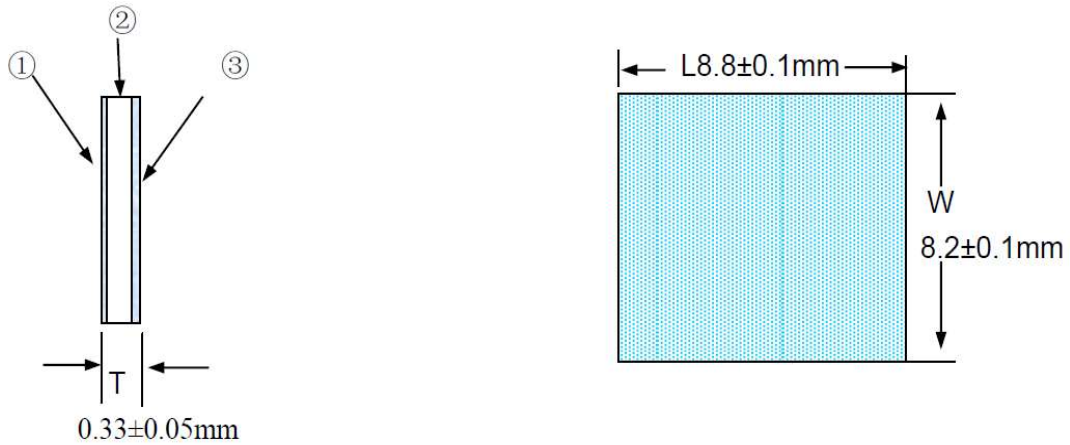

| Part No | Part Name         | Dimension(mm) |        |          | Orientation Angle | Rotation Angle | Flatness | Para. |
|---------|-------------------|---------------|--------|----------|-------------------|----------------|----------|-------|
|         |                   | L             | W      | T        |                   |                |          |       |
| ①       | IR Coating        |               |        |          |                   |                |          |       |
| ②       | Double refractive | 8.8±0.        | 8.2±0. | 0.33±0.0 | 45                | 0              | 3N       | 2'    |
| ③       | AR Coating        |               |        |          |                   |                |          |       |

| Wave Length(nm) | Transmission (%) |
|-----------------|------------------|
| 400nm           | >75%             |
| 450~600nm       | >80%             |
| 645 ± 10nm      | =50%             |
| 700nm           | <5%              |
| 1100nm          | <15%             |

### 5-1-3. OLPF for TDN lens(OLPF Manufacturer : Max Gain)

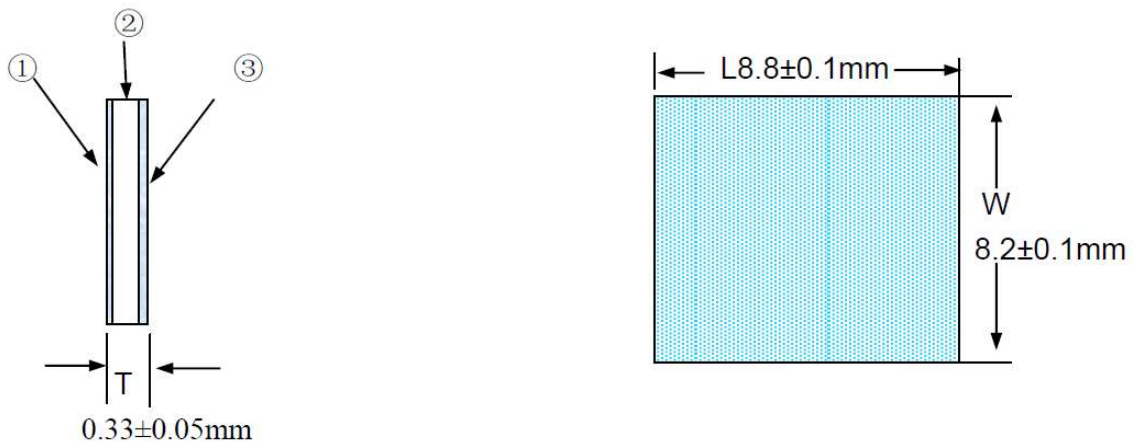



| Part No | Part Name         | Dimension(mm) |        |          | Orientation Angle | Rotation Angle | Flatness | Para |
|---------|-------------------|---------------|--------|----------|-------------------|----------------|----------|------|
|         |                   | L             | W      | T        |                   |                |          |      |
| ①       | AR Coating        |               |        |          |                   |                |          |      |
| ②       | Double refractive | 8.8±0.        | 8.2±0. | 0.33±0.0 | 45                | 0              | 3N       | 2'   |
| ③       | AR Coating        |               |        |          |                   |                |          |      |

| Wave Length(nm) | Transmission (%) |
|-----------------|------------------|
| 420~1100nm      | >96%             |
|                 |                  |

#### 5-1-4. OLPF for Night Vision(OLPF Manufacturer : Max Gain)

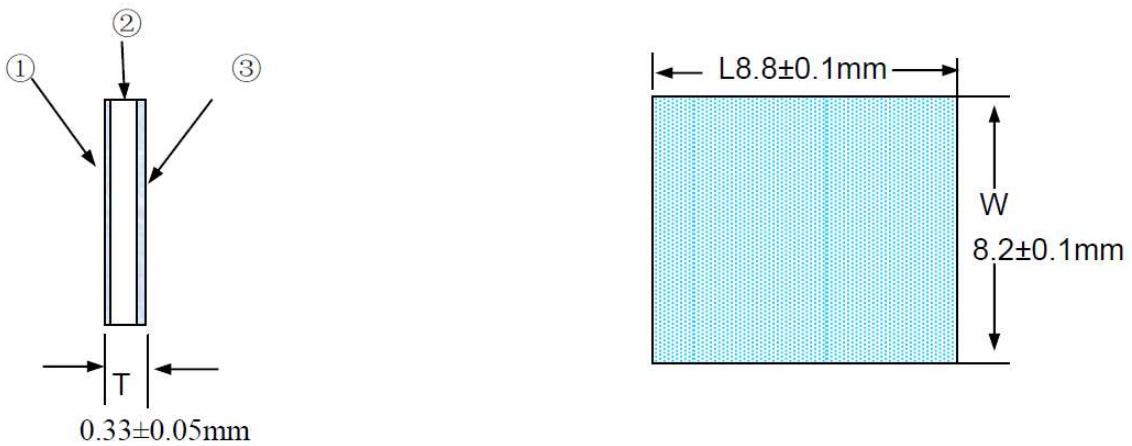

| Part No | Part Name            | Dimension(mm) |        |          | Orientation Angle | Rotation Angle | Flatness | Para |
|---------|----------------------|---------------|--------|----------|-------------------|----------------|----------|------|
|         |                      | L             | W      | T        |                   |                |          |      |
| ①       | Night vision Coating |               |        |          |                   |                |          |      |
| ②       | Double refractive    | 8.8±0.        | 8.2±0. | 0.33±0.0 | 45                | 0              | 3N       | 2'   |
| ③       | AR Coating           |               |        |          |                   |                |          |      |

| Wave Length(nm) | Transmission (%) |
|-----------------|------------------|
| 400-420         | >75%             |
| 421-620         | >85%             |
| 645±10          | 50%              |
| 700-750         | <3%              |
| 815±15          | 50%              |
| 850             | >80%             |
| 900-1100        | <20%             |



## 5-2. I/O Connector Specifications

### 5-2-1. 12505WS-XXA00 Series

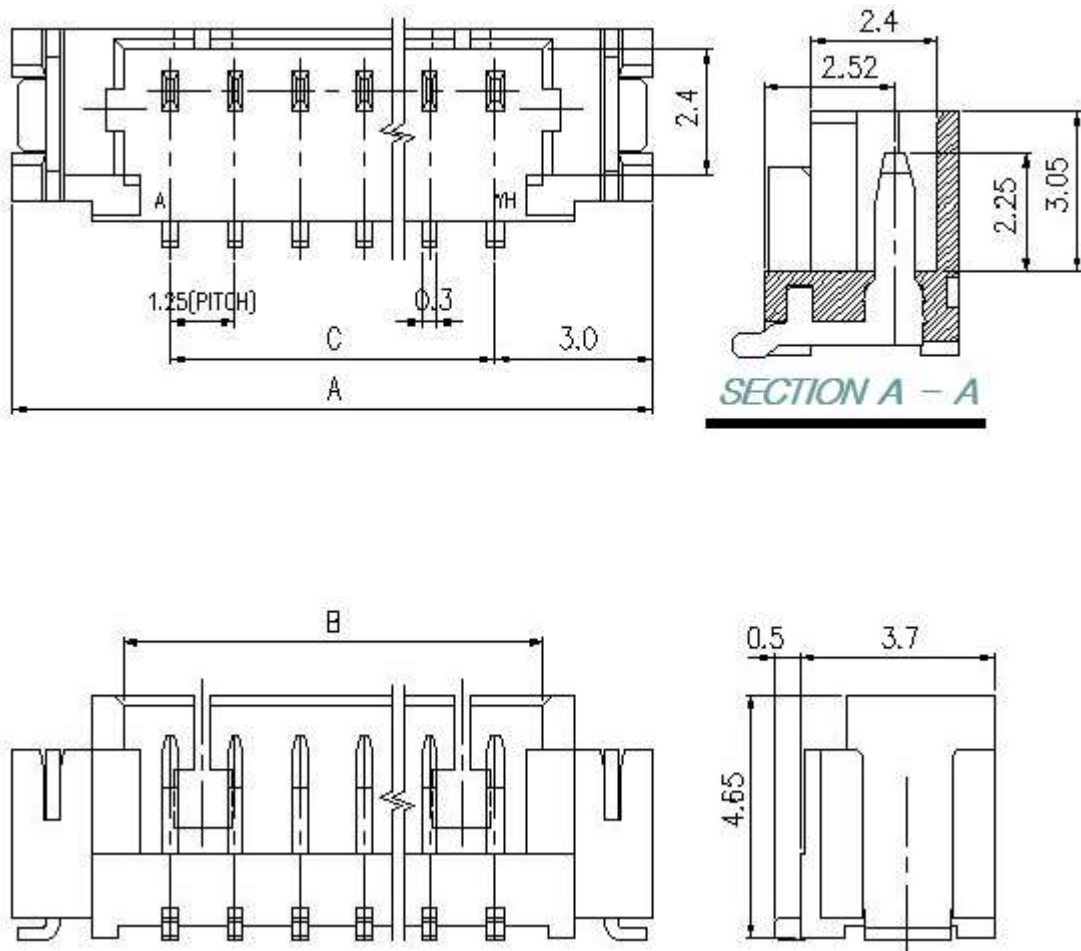

#### Available Pin

| PARTS NO.  | A     | B     | C     |
|------------|-------|-------|-------|
| 12505WS-02 | 7.25  | 3.05  | -     |
| 12505WS-03 | 8.50  | 4.30  | 2.50  |
| 12505WS-04 | 9.75  | 5.55  | 3.75  |
| 12505WS-05 | 11.00 | 6.80  | 5.00  |
| 12505WS-06 | 12.25 | 8.05  | 6.25  |
| 12505WS-07 | 13.50 | 9.30  | 7.50  |
| 12505WS-08 | 14.75 | 10.55 | 8.75  |
| 12505WS-09 | 16.00 | 11.80 | 10.00 |
| 12505WS-10 | 17.25 | 13.05 | 11.25 |
| 12505WS-11 | 18.50 | 14.30 | 12.50 |
| 12505WS-12 | 19.75 | 15.55 | 13.75 |
| 12505WS-13 | 21.00 | 16.80 | 15.00 |
| 12505WS-14 | 22.25 | 18.05 | 16.25 |
| 12505WS-15 | 23.50 | 19.30 | 17.50 |

#### Specification

| ITEM                   | SPEC          |
|------------------------|---------------|
| Voltage Rating         | AC/DC 125V    |
| Current Rating         | AC/DC 1A      |
| Operating Temperature  | -25°C ~ +85°C |
| Contact Resistance     | 30mΩ MAX      |
| Withstanding Voltage   | AC250V/1min   |
| Insulation Resistance  | 100MΩ MIN     |
| Applicable Wire        | -             |
| Applicable P.C.B       | 0.8 ~ 1.6mm   |
| Applicable FPC/FFC     | -             |
| Solder Height          | 0.15mm        |
| Crimp Tensile Strength | -             |
| UL FILE NO             | E108706       |